

R O S E T T A
FLIGHT REPORTS
of RPC-MAG

RO-IGEP-TR-0015

Issue: 1 Revision: 2

August 3, 2005

Anomaly Report & Analysis

of the

MAG-OB Failure in June 2005

Andrea Diedrich
Karl-Heinz Glassmeier
Ingo Richter

Institut für Geophysik und extraterrestrische Physik
Technische Universität Braunschweig
Mendelssohnstraße 3, 38106 Braunschweig
Germany

R O S E T T A	Document: RO-IGEP-TR-0015
	Issue: 1
	Revision: 2
IGEP Institut für Geophysik u. extraterr. Physik Technische Universität Braunschweig	Date: August 3, 2005
	Page: I

Contents

1 Introduction	1
2 Event description	2
2.1 Diagnosis	3
3 Conclusion	5
A Plots of the IB and OB Sensors - Science Data	5
B Plots of the Housekeeping Data	8
C Magnetic Field (OB-Sensor) inside the HK Data	13
D PLOTS of the Total RPC Current	18
E The RPCMAG FGM Driver Electronics	19
F The Sensor Temperatures and s/c Attitude during the Period June,16.-21.	20
G RFW for Thermal Tests	21

R O S E T T A	Document: RO-IGEP-TR-0015
IGEP Institut für Geophysik u. extraterr. Physik Technische Universität Braunschweig	Issue: 1
	Revision: 2
	Date: August 3, 2005
	Page: 1

1 Introduction

This Analysis Report is related to the Anomaly Report ROS-SC-91 :

 Anomaly Report Tracking System					
Project	Rosetta Spacecraft Anomalies			Project ID	ROS_SC
SC	MAG sensor not working	State	Open	ID	ROS_SC-91
Originator	Armelle Hubault	Criticality	Low	Event Type	Unexpected_Event/Behaviour
Created	2005-06-21 15:07	Urgency	Low	Type	Local
Occurrence Date	2005-06-17	Reproducibility	Unknown	Classification	Space Segment Payload RPC
Description					
Description	<p>During RPC activities on DOY 2005.167, MAG team reported a problem with one of MAG sensors. Analysis shows that the sensor did not work between DOY 167 and DOY 170 (16 to 19 June); it failed since the switch on at 167:08:35 until the switch off at 170:23:00.</p> <p>A power cycle was subsequently requested on DOY 172 and this solved the problem. The switch on temperature on DOY 172 was -129 C -- the same as on DOY 167.</p>				
Item Configuration					
Environment					
Recommendation					
Affected Requirement					
Processing					
Root Cause	Unknown				
Preventive Action	No				
Resolution					
Related Files					
No files are attached to this Report					
Actions					
No actions assigned to this AR					
Related Reports					
No Reports related to this Report					

Figure 1: Anomaly Report: AR-ROS-91

R O S E T T A	Document: RO-IGEP-TR-0015
IGEP Institut für Geophysik u. extraterr. Physik Technische Universität Braunschweig	Issue: 1
	Revision: 2
	Date: August 3, 2005
	Page: 2

2 Event description

Studies about cometary orbits revealed the unique chance to meet the tail of the just recently discovered comet P/CATALINA. Our Swedish colleagues from the RPC-LAP team computed, that ROSETTA would pass CATALINA's plasma tail at a distance of just 10 Million kilometers in the time period June 17. - 19., 2005. Therefore, it was decided to switch on RPC on July 16. and perform measurements until June 19.

On the first view everything looked nominal. According to our HK data all necessary voltages had the right values (refer to the plots in Appendix B) and the RPC-MAG IB sensor transmitted reasonable data in the usual manner (refer to Figure 2). The OB sensor, however, sent a faulty signal (refer to Figure 3):

- the B_x component was permanently saturated.
- the B_y component showed erratic variations of a few thousand Nanotesla.
- the B_z component was permanently saturated.

This behavior did not change over the whole operation period until the switch off on June 19. The OB data looked erroneous in the science packets (sampled by 3 individual 20 bit ADCs) and the housekeeping packets (sampled by a different 16 bit ADC) as well (refer to Appendix C). The temperature of the IB and OB sensor (thermistors inside the magnetic field sensors) was, however, measured in the right way (refer to Figure 17).

As only the OB sensor failed and the other parts of the instrument were working nominally, we could be quite sure that there was at no time any danger for the other RPC-Instruments or the spacecraft. Therefore, RPC stayed powered on until the evening of June 19 (ROSETTA was out of pass anyway) and was switched off via MTL at 2005-06-19T23:15.

The next switch on was executed manually at 2005-06-21T08:02. Now everything was nominal as usual. The complete instrument, both sensors, worked fine as all the time before.

RPC was finally switched off manually at 2005-06-21T16:29.

Remark:

The increased noise level of the IB sensor is caused by the variations of the OB-Y sensor with an amplitude of some thousand Nanotesla. Both sensors are only 15 cm apart. Therefore, the huge OB-Y variations have a magnetic influence to the IB sensor in the order of some Nanotesla.

R O S E T T A	Document: RO-IGEP-TR-0015 Issue: 1 Revision: 2
IGEP Institut für Geophysik u. extraterr. Physik Technische Universität Braunschweig	Date: August 3, 2005 Page: 3

2.1 Diagnosis

There were detailed discussions inside the MAG team about the erroneous behavior. The first guess was that there might occur problems due to the low sensor temperature. Studying our instrument development description, however, revealed, that the sensors have been operated (several power on/off cycles) down to at least -160°C during the development phase (refer to the test description in the RFW sheet, Appendix G). Therefore, a temperature effect was discarded as error source. An in depth analysis, excluding the nominal working instrument parts step by step, should help to locate the origin of the error:

- RPC was powered on nominally in terms of stable voltages.
- All necessary voltages (+5V, -5V, $U_{\text{ref}}=2.5\text{V}$) were present as expected ¹ (proofed by HK data, refer to Appendix B).
- Data were transmitted in HK and Science frames.
- The Thermistors inside the OB and IB sensors worked properly.
- The IB sensor worked nominally.
- OB science and OB HK values showed the same signature.
- The overall RPC current was nominal (refer to the Figures in Appendix D)
- Readings are constant but not zero. Therefore, a loose contact in the connectors or harness can be screened out.
- The failure must be originated somewhere in the OB part of the instrument rather than in any commonly used section.

Due to this facts the only possible error source seems to be:

- Excitation of OB missing or faulty.

With this assumption the error source can be encircled a bit more:

- Oscillator failure.
 \rightsquigarrow Not possible, as RPC-MAG is operating with only one master oscillator working on $f_0=4.19443\text{MHz}$.
All frequencies needed for the whole instrument are derived from this oscillator. As the s/w runs properly, the FPGAs must work properly as well (the FPGAs need the master clock!): f_0 signal is obviously present.

¹However, there can not be made any statement about transient switch on events, as the HK sampling rate is only 1 frame per 32 s. For such an analysis we would need an oscilloscope access to the RPC unit....

<h1 style="margin: 0;">R O S E T T A</h1>	Document: RO-IGEP-TR-0015 Issue: 1 Revision: 2 Date: August 3, 2005 Page: 4
<h2 style="margin: 0;">IGEP</h2>	Institut für Geophysik u. extraterr. Physik Technische Universität Braunschweig

- The master clock f_0 is divided by 84 to generate an input frequency of $f_1 = 50$ kHz for the FGM drive electronics (refer to circuit diagram in Appendix E). Furthermore this frequency is divided by 2 times 2 to provide the needed $f_2 = 25$ kHz and $f_3 = 12.5$ kHz. Thus, up to this point the failure probability is extremely low.
- The most likely failure source is the complex behavior of the resonant circuit consisting of L_1 , C_s and the sensor excitation coil (refer to the right side of Figure 16) during the power on phase.

Rationale:

The described resonant circuit has to oscillate exactly on his resonance frequency of 12.5 KHz. This can only be guaranteed, if during the RPCMAG activation phase enough power is provided via the s/c or RPC PIU power supply. It is absolutely necessary that the supply voltage rises "immediately" with a steep flank. If the flank is to flat, respective the slew rate is to slow, the resonant circuit is not able to draw the high initial current needed to fall into the right oscillation state (the resonant circuit is not excited with a simple sinusoidal signal but with steep needle pulses to minimize power consumption. Therefore, sufficient power has to be provided to generate even the first needle pulse in the right height). It might happen that the circuit will not start oscillating which will of course cause a failure behavior.

This behavior is a known fact from the development time of the instrument and has also been reproduced recently with a RPCMAG prototype unit at IGEP TU-BS using a "soft" power supply. The failure did, however, not occur if the supply voltages were switched on and connected instantaneously using a relais.

The observed failure never happened during s/c ground tests or in flight (until now) with the original s/c power units. Maybe the instrument was switched on in an inconvenient moment, when there were spikes on the main power lines or the s/c power consumption was to high for a very short time. Therefore, we had a look to the total drawn current by RPC (refer to Appendix D). These figures, however, do not show any abnormal behavior. But the time resolution (1 Minute) and also the current resolution is not high enough to reveal transient start-up events.

R O S E T T A	Document: RO-IGEP-TR-0015 Issue: 1 Revision: 2
IGEP Institut für Geophysik u. extraterr. Physik Technische Universität Braunschweig	Date: August 3, 2005 Page: 5

3 Conclusion

The observed failure in June, 2005 did not leave any damage behind. All RPC is again working nominal.

The failure source can not be located definitely, but with the utmost probability, a catenation of unfortunate circumstances lead through a faulty oscillation of the resonant circuit in the sensor excitation drive. This is an absolutely uncritical error which can be corrected by a repeated Power off/on cycle.

The best modus operandi for RPCMAG would of course be to switch the instrument on, ensure that it works nominally, and leave it in the powered state to minimize the power on cycles.

A Plots of the IB and OB Sensors - Science Data

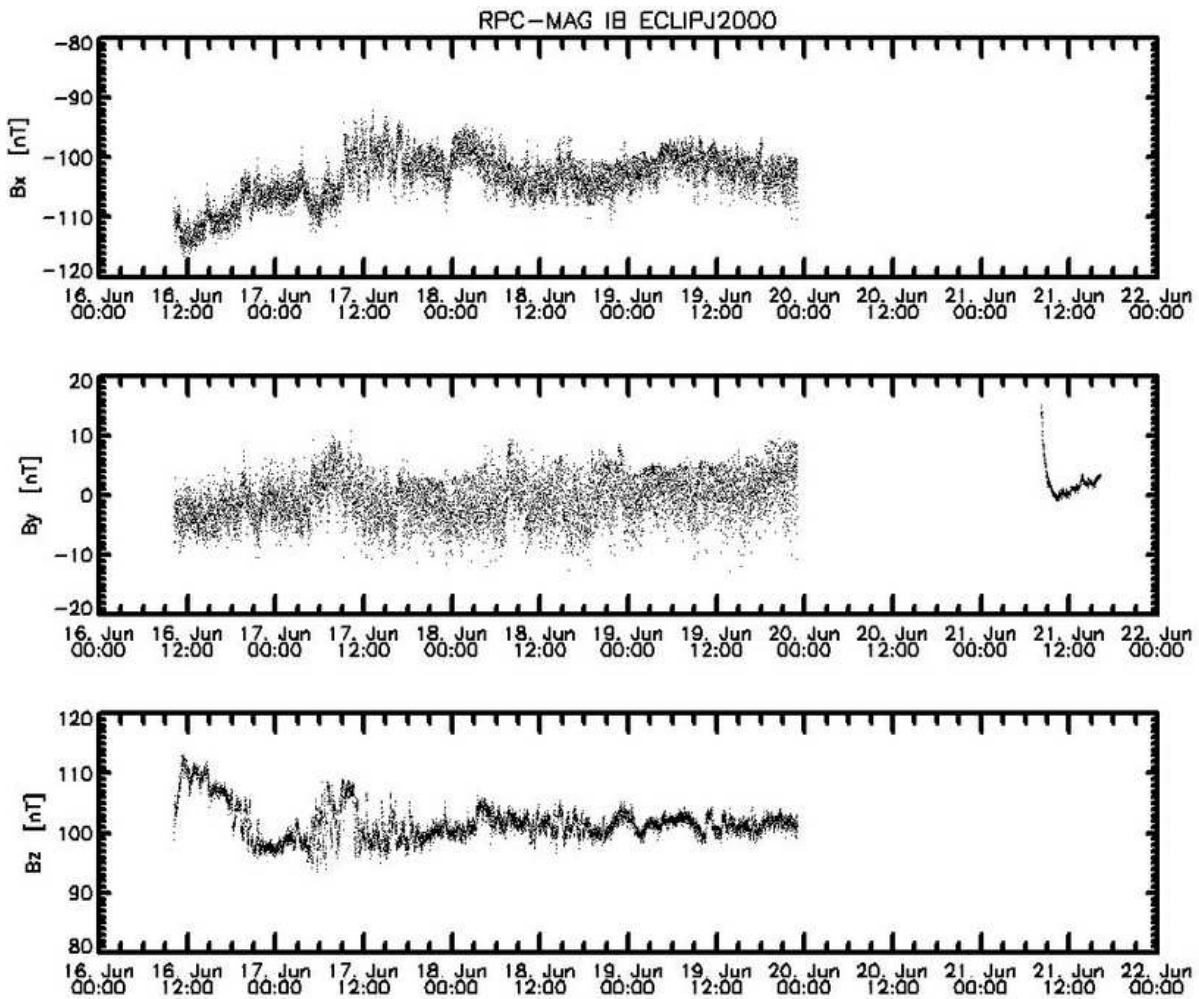

Figure 2: RPCMAG: Magnetic field measured with the IB Sensor

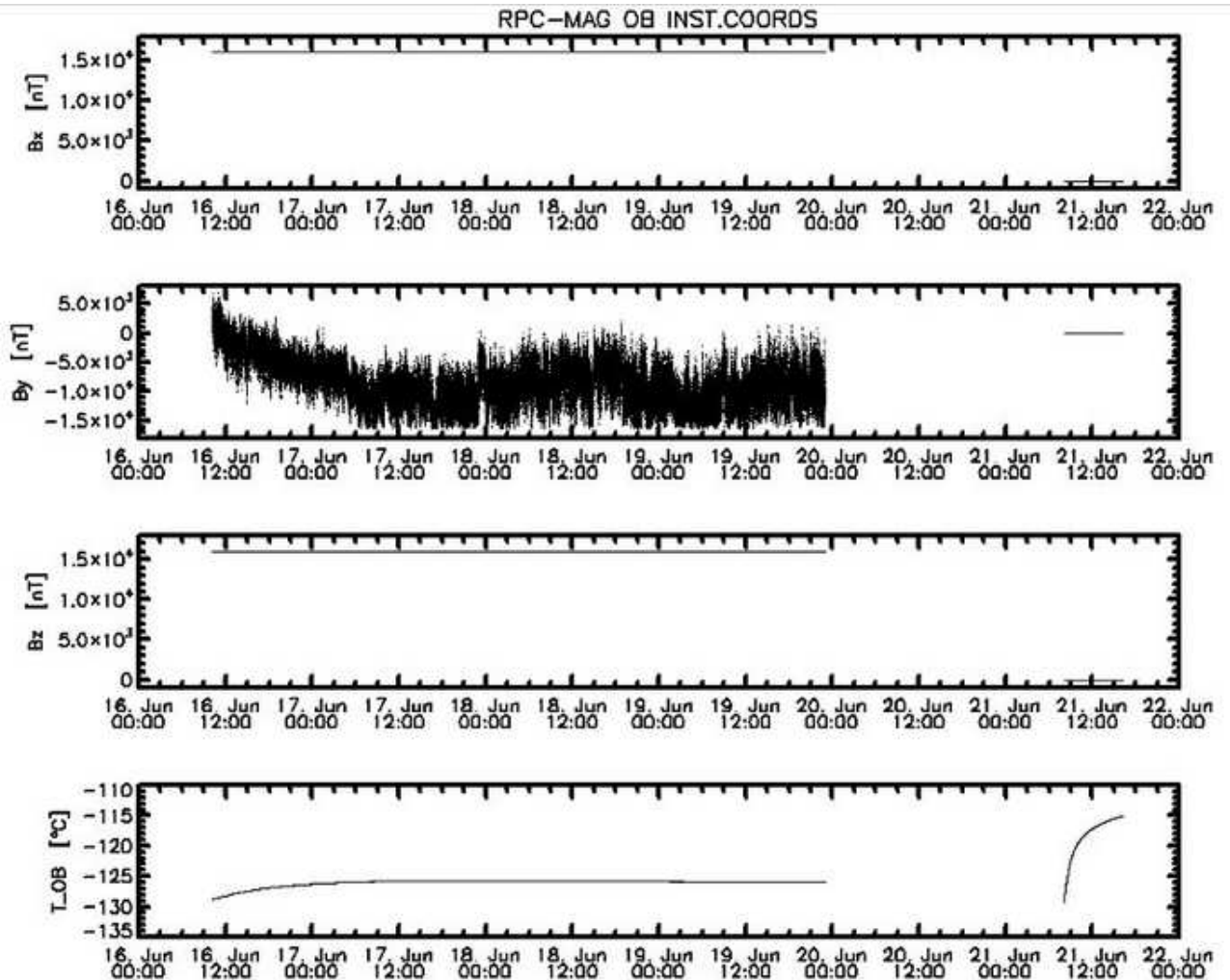
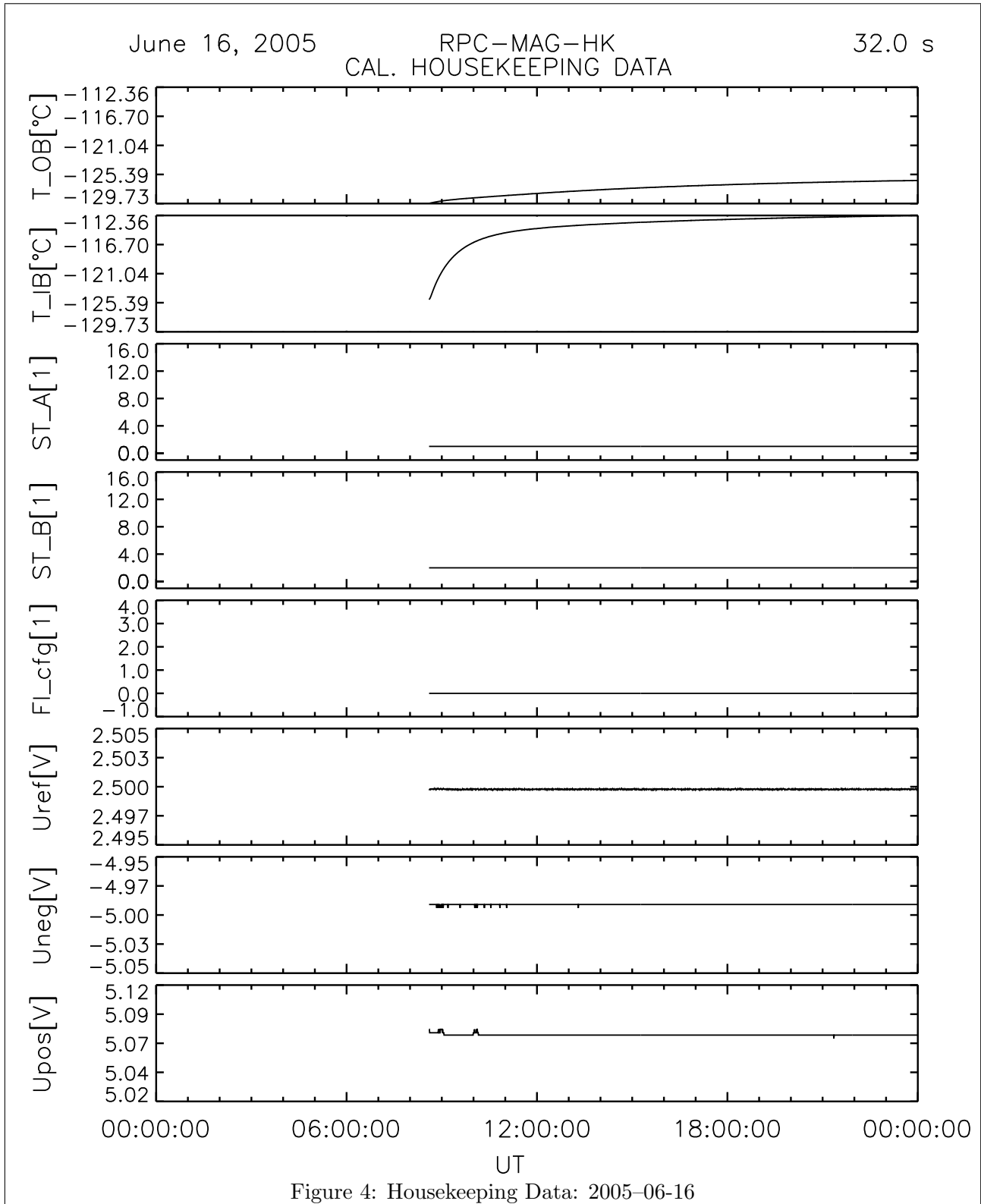

Figure 3: RPCMAG: Magnetic field measured with the OB Sensor

B Plots of the Housekeeping Data



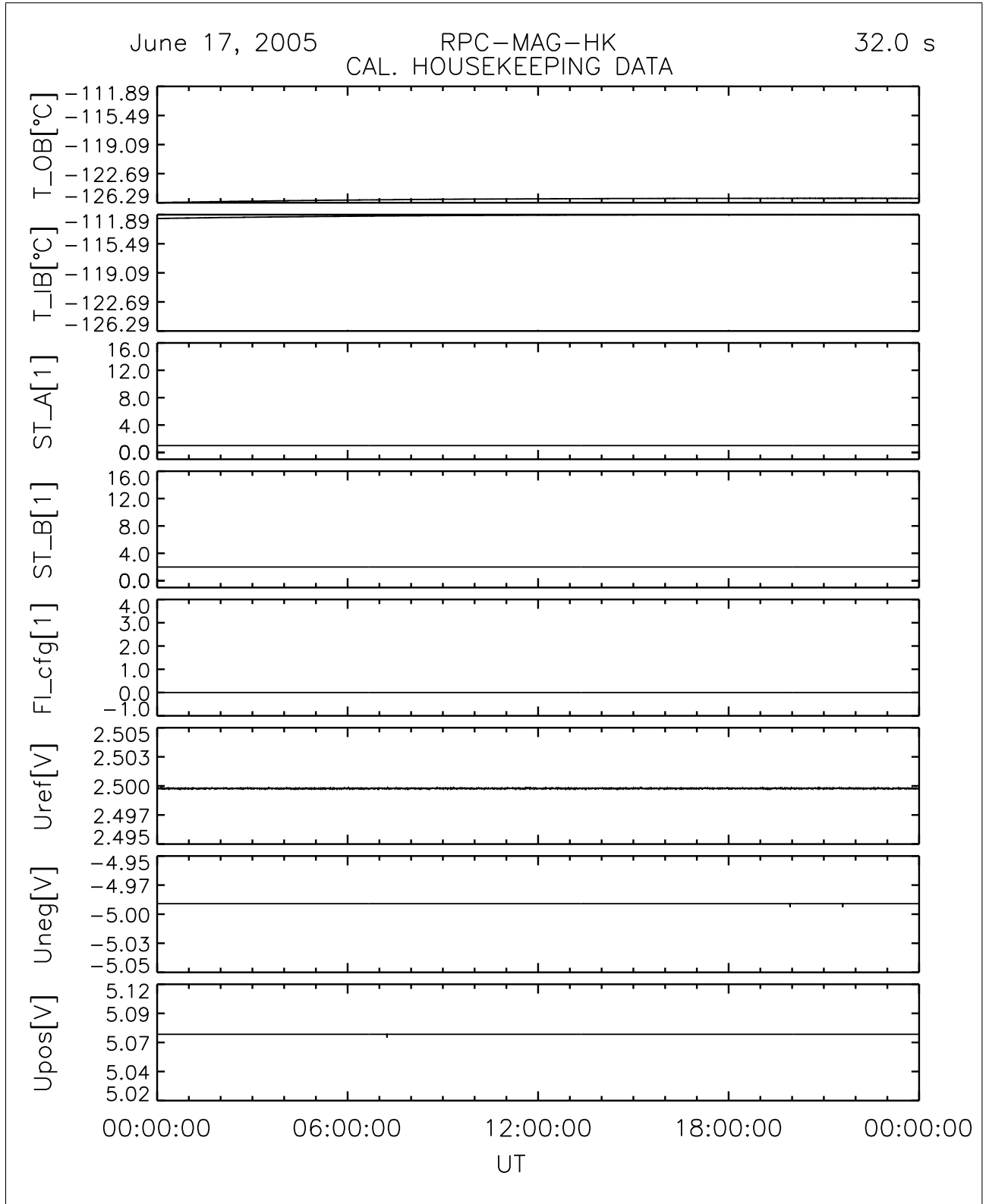

Figure 5: Housekeeping Data: 2005-06-17

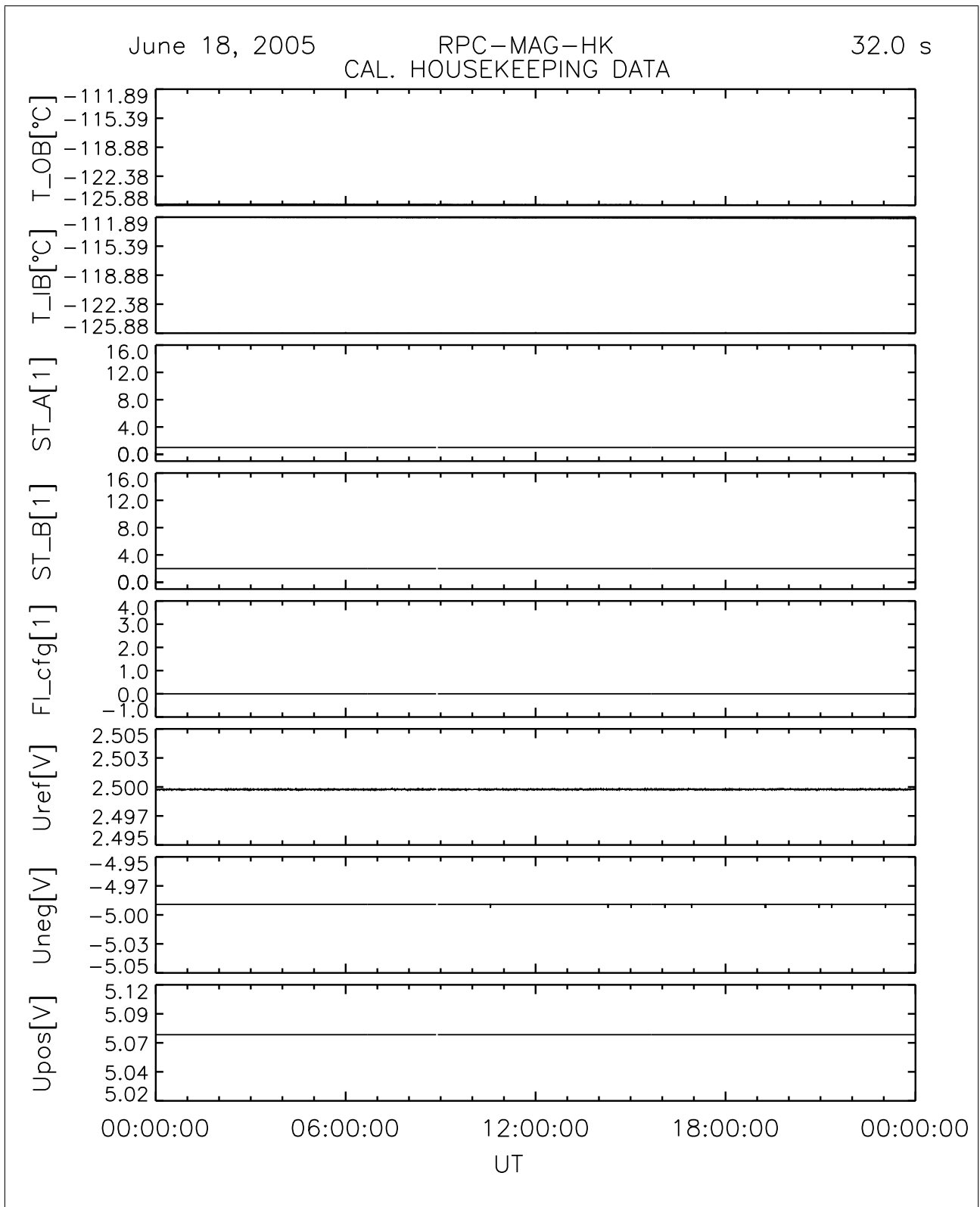

Figure 6: Housekeeping Data: 2005-06-18

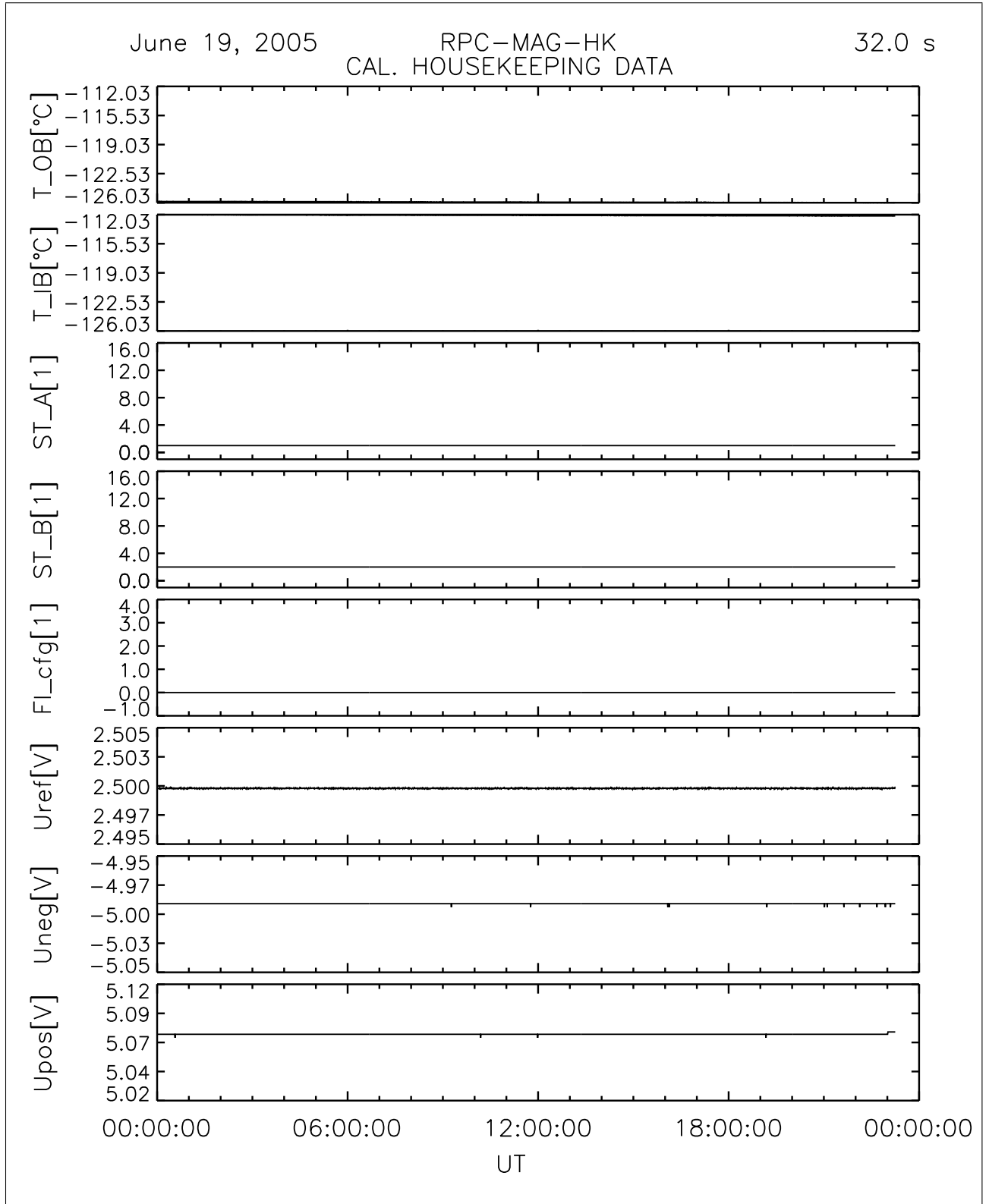

Figure 7: Housekeeping Data: 2005-06-19

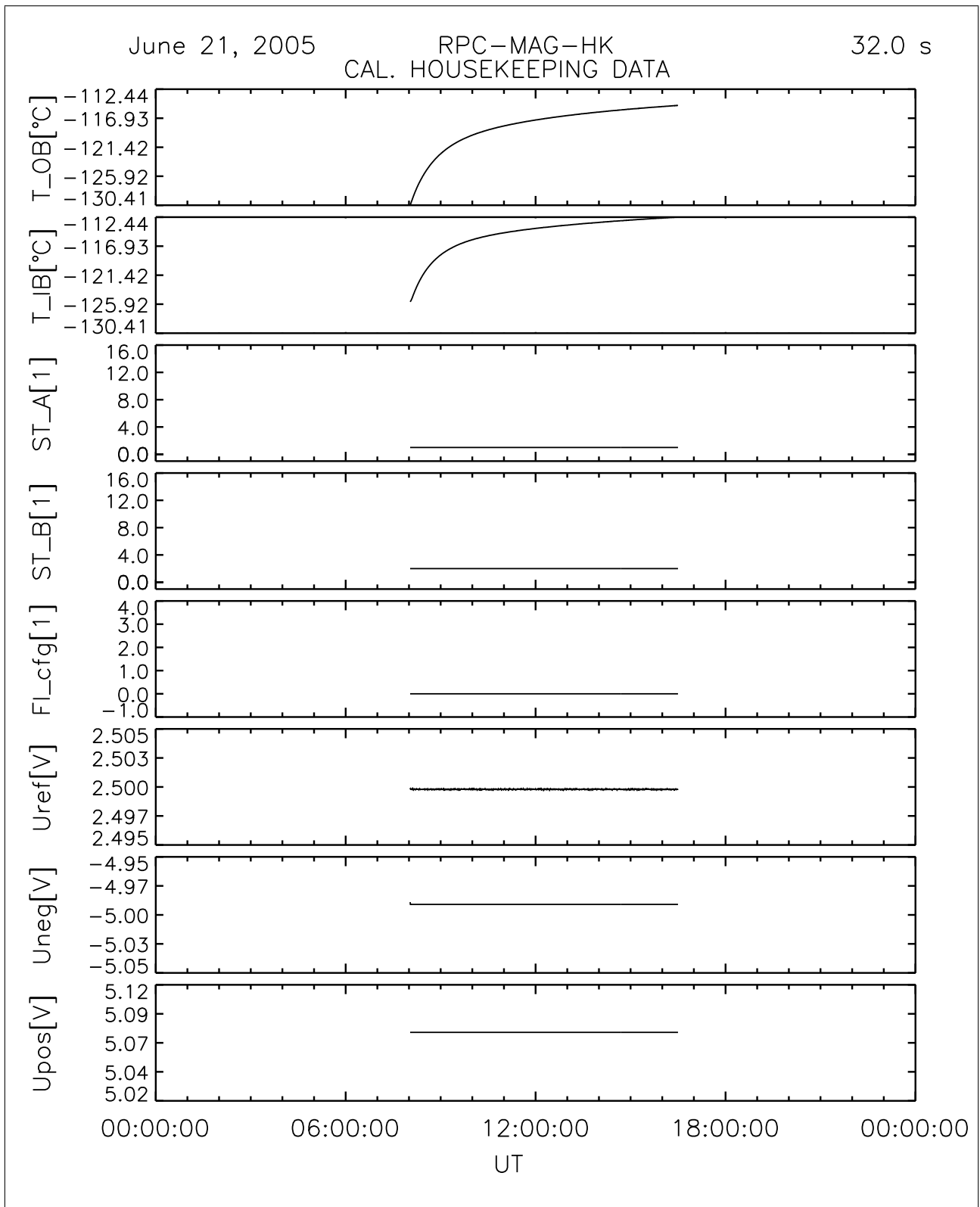
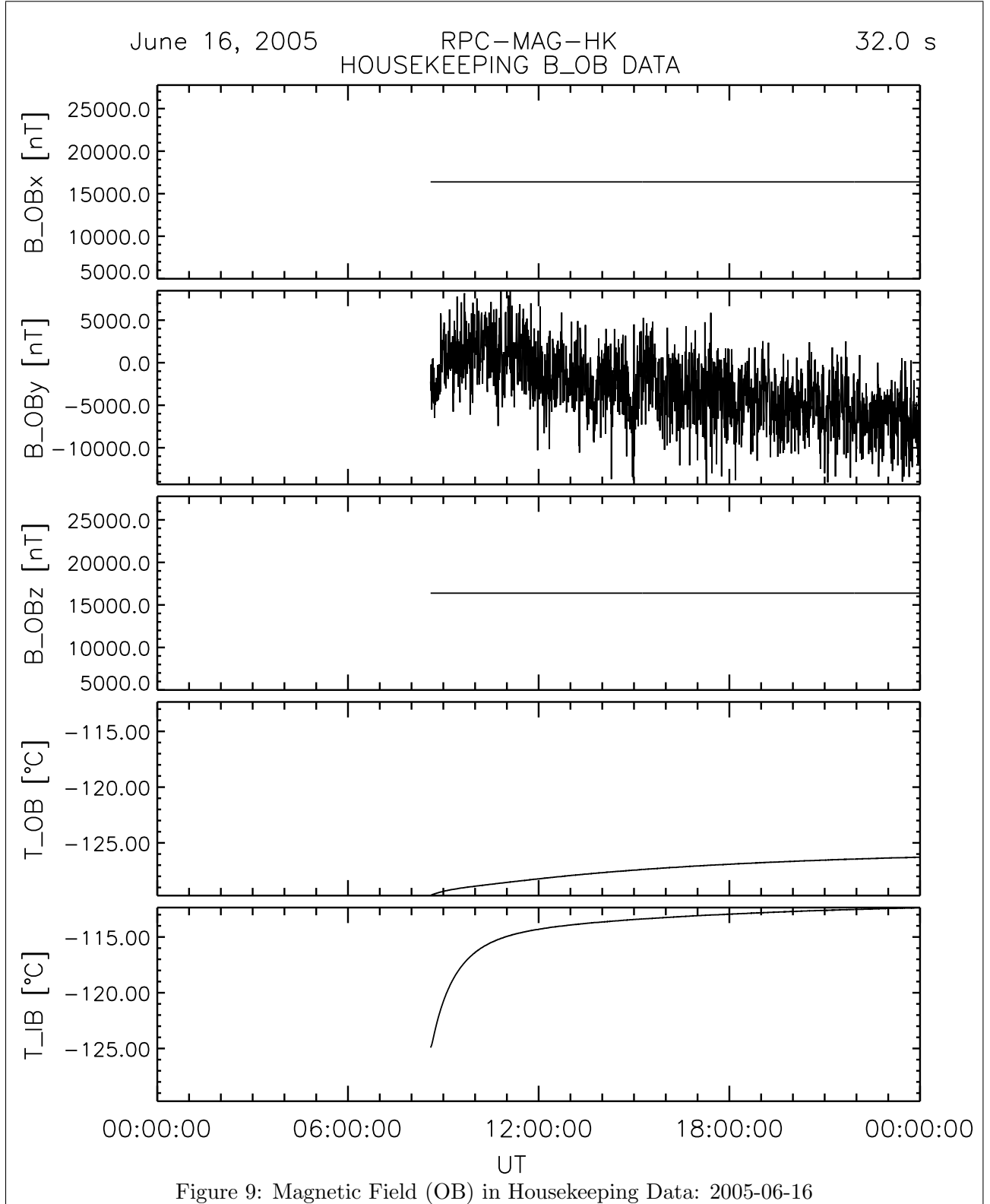

Figure 8: Housekeeping Data: 2005-06-21

C Magnetic Field (OB-Sensor) inside the HK Data



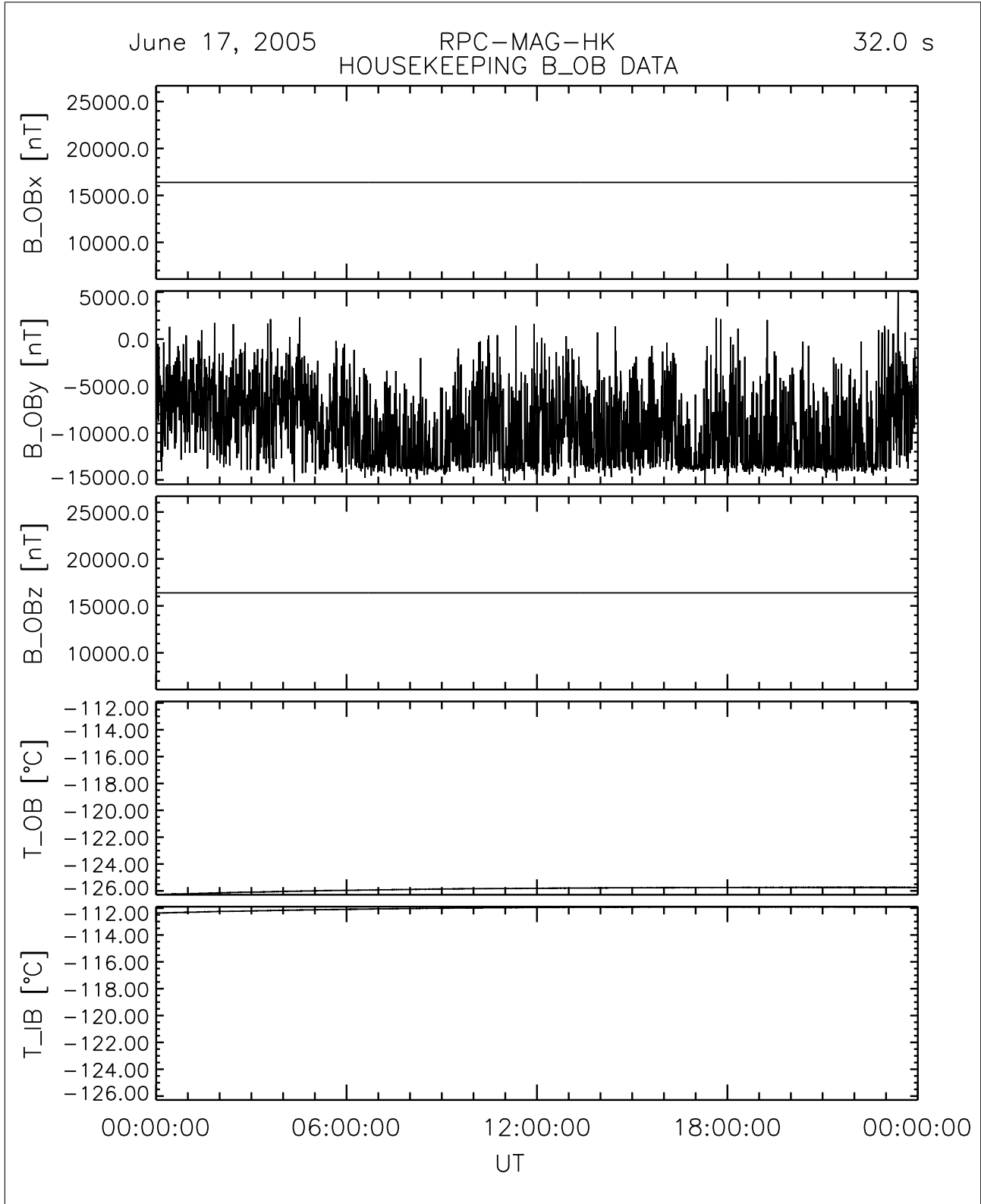

Figure 10: Magnetic Field (OB) in Housekeeping Data: 2005-06-17

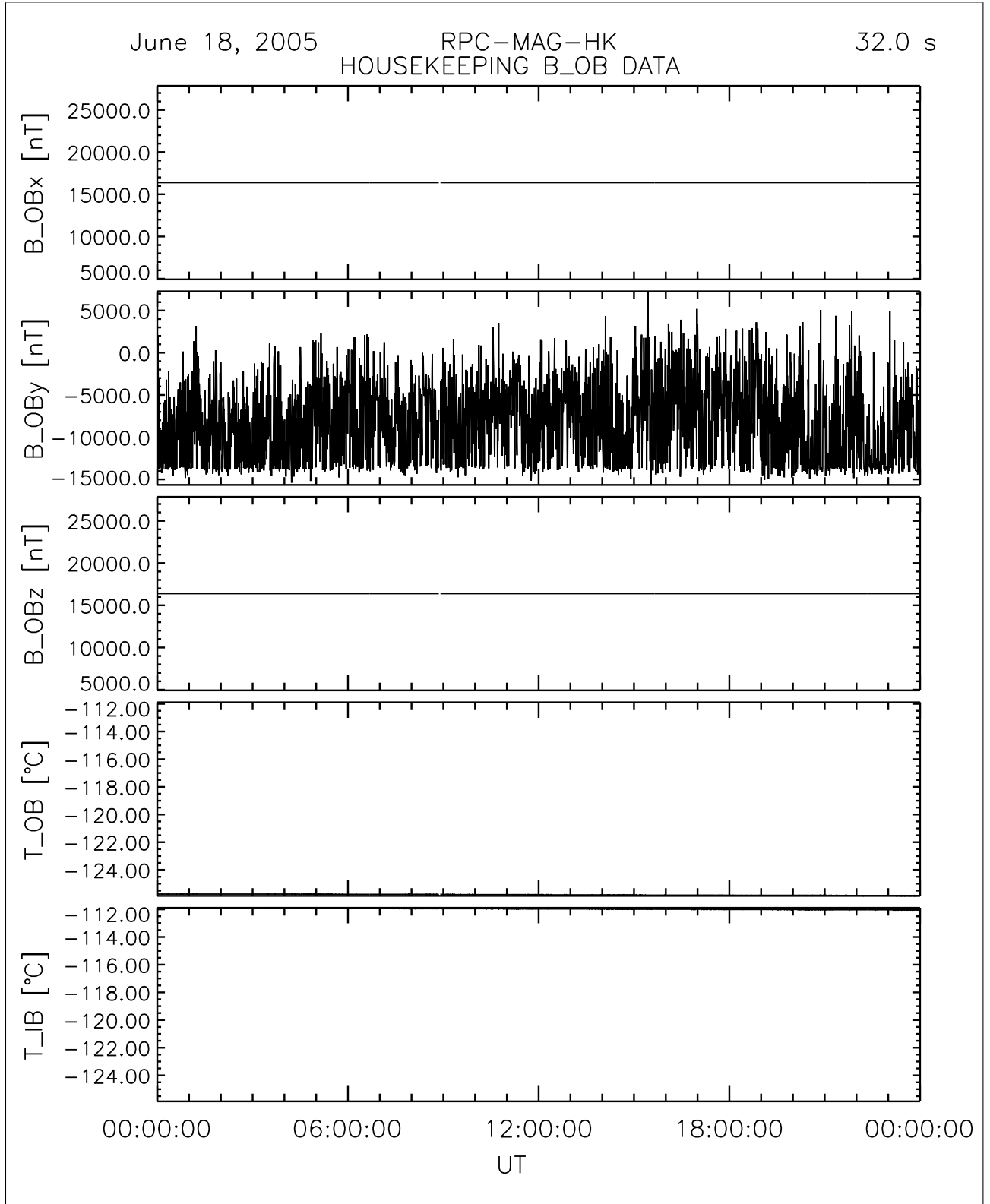

Figure 11: Magnetic Field (OB) in Housekeeping Data: 2005-06-18

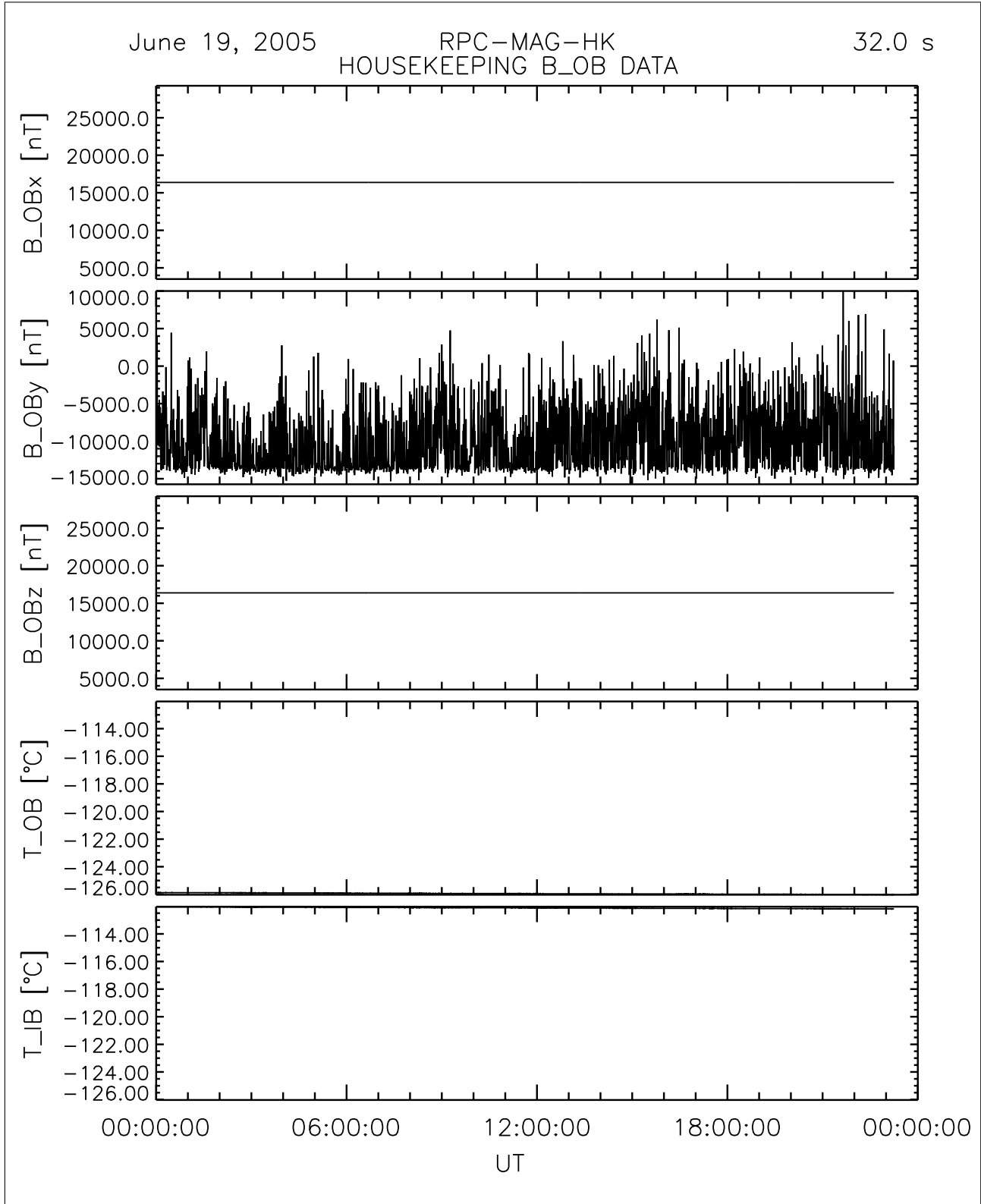

Figure 12: Magnetic Field (OB) in Housekeeping Data: 2005-06-19

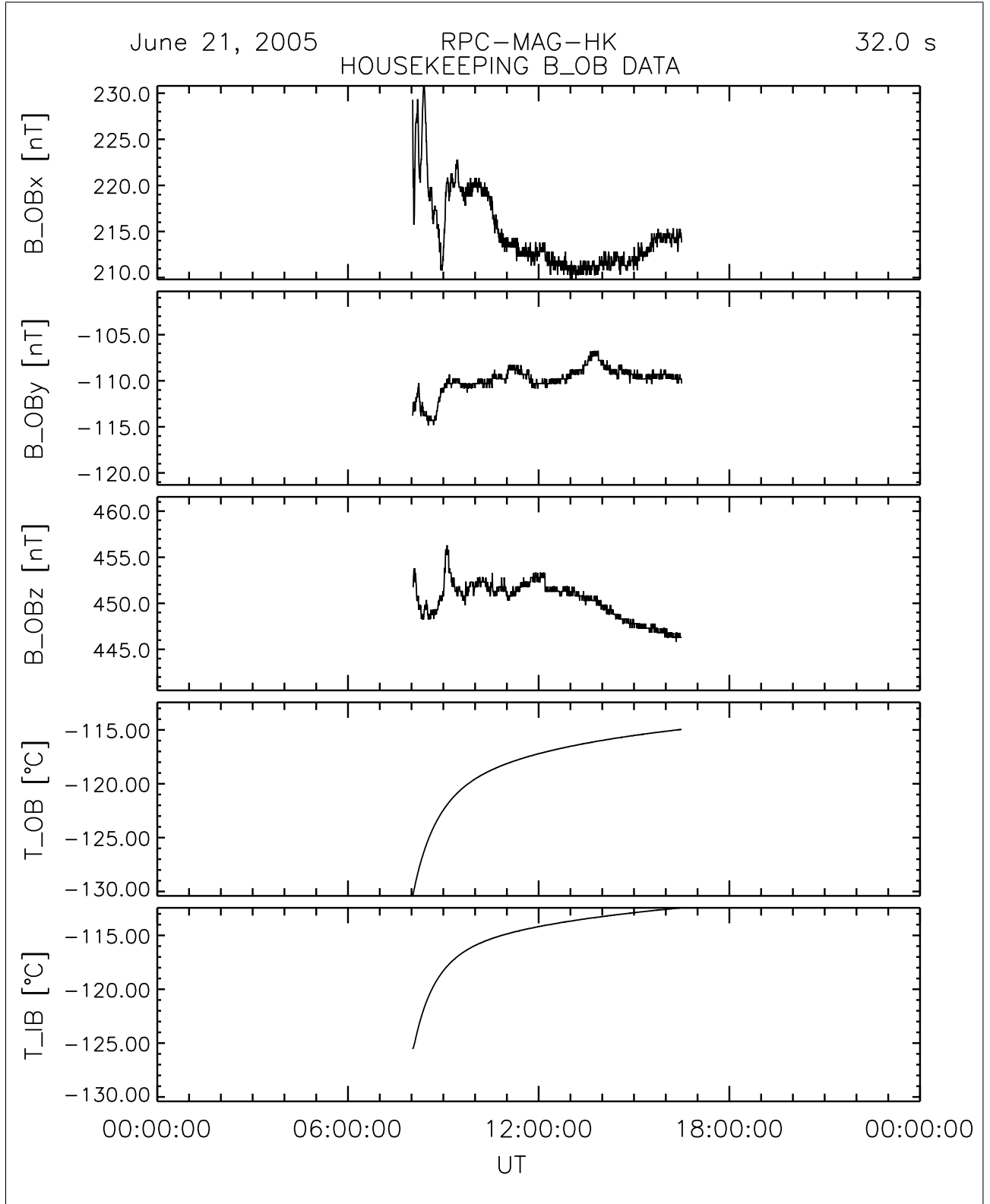

Figure 13: Magnetic Field (OB) in Housekeeping Data: 2005-06-21

D PLOTS of the Total RPC Current

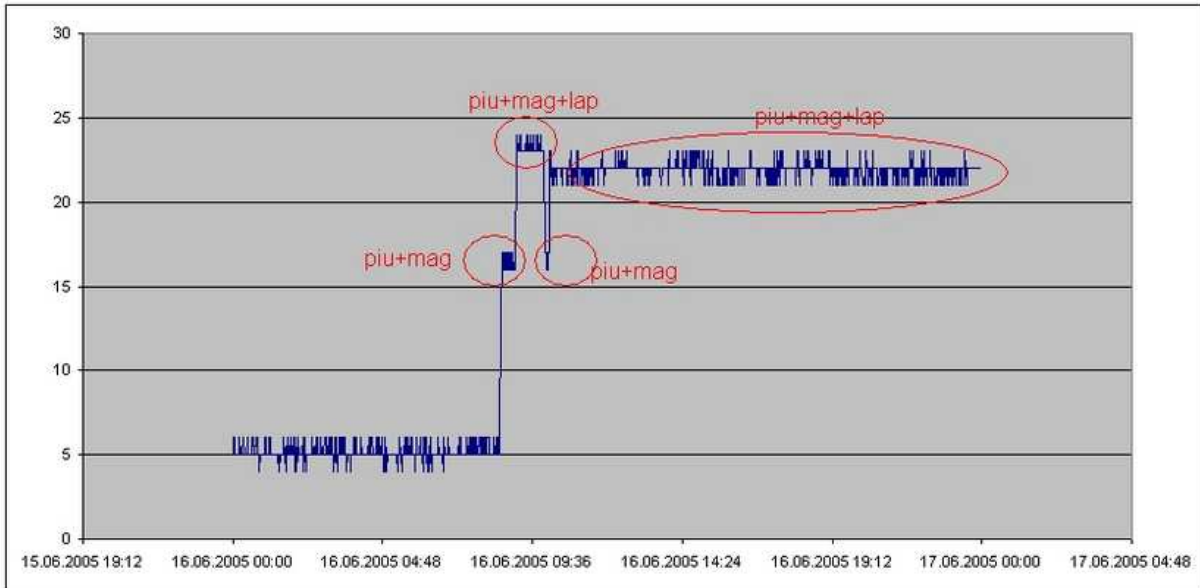

Figure 14: RPC: Total Current (in relative units): 2005-06-16

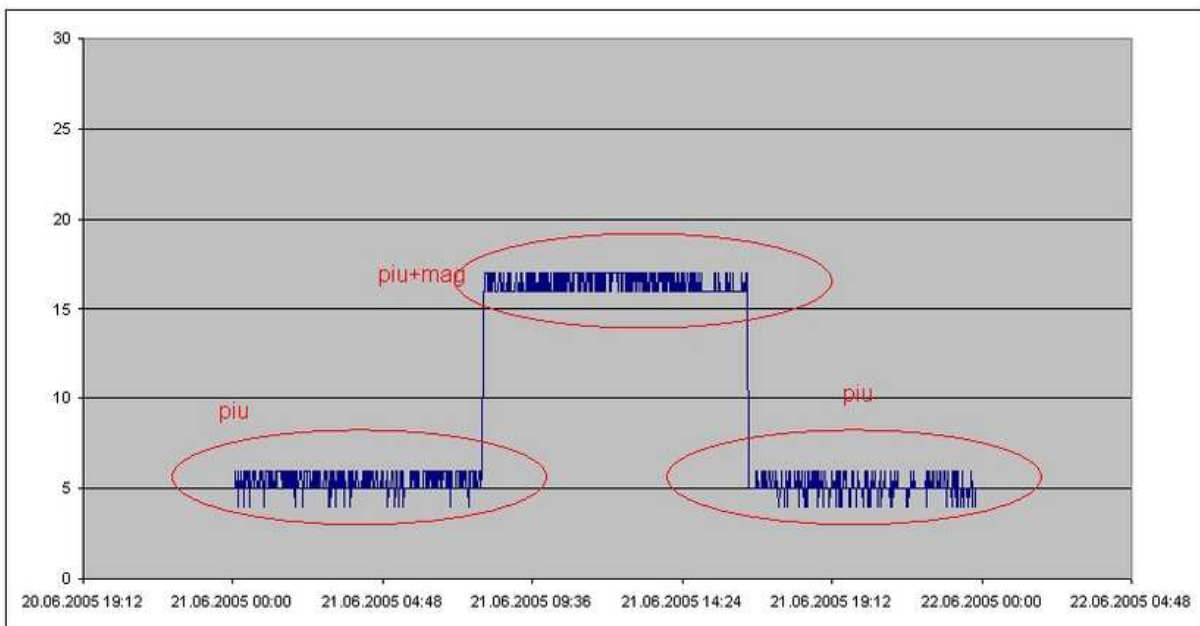

Figure 15: RPC: Total Current (in relative units): 2005-06-21

E The RPCMAG FGM Driver Electronics

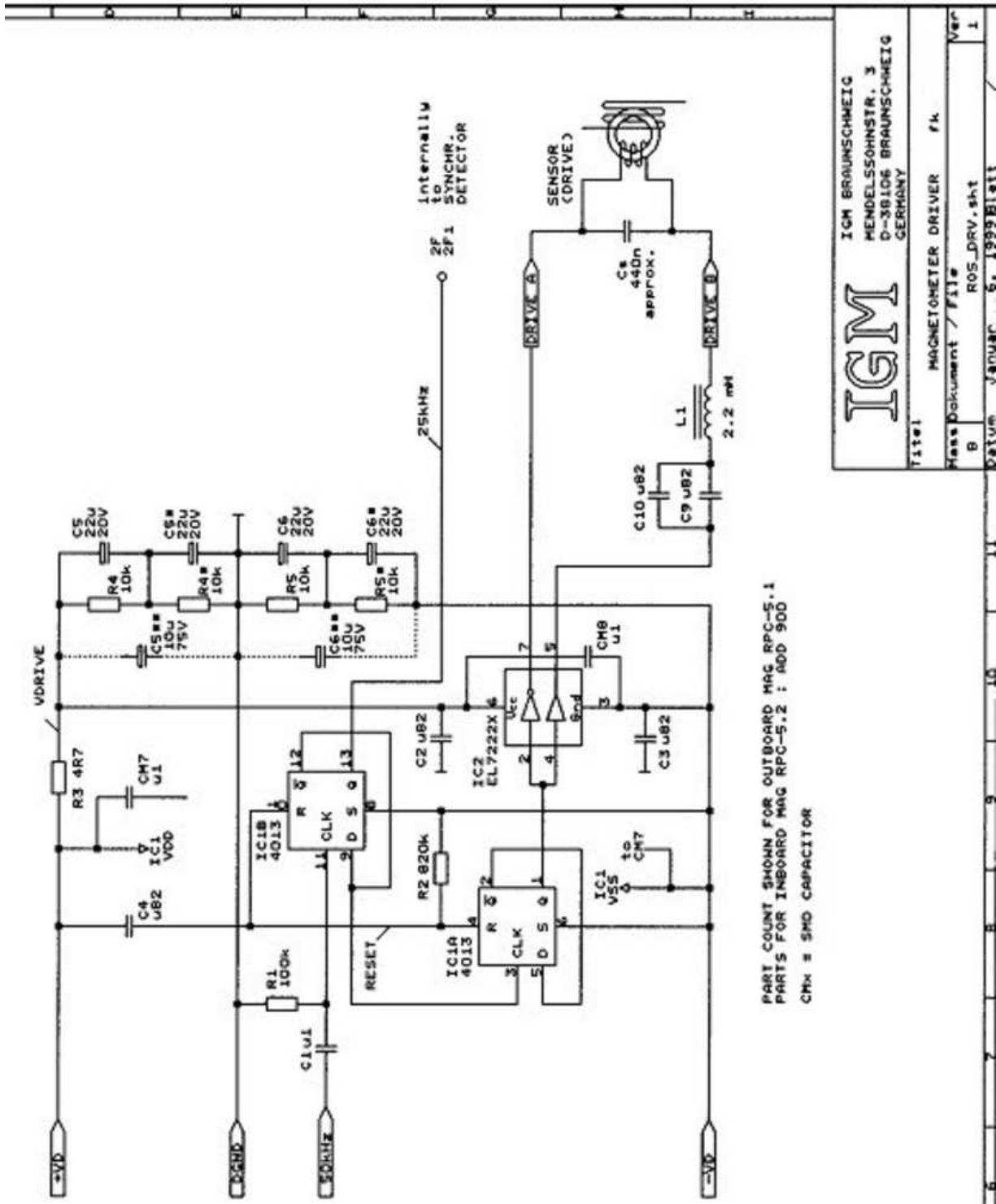

Figure 16: RPCMAG Driver Electronics

F The Sensor Temperatures and s/c Attitude during the Period June,16.-21.

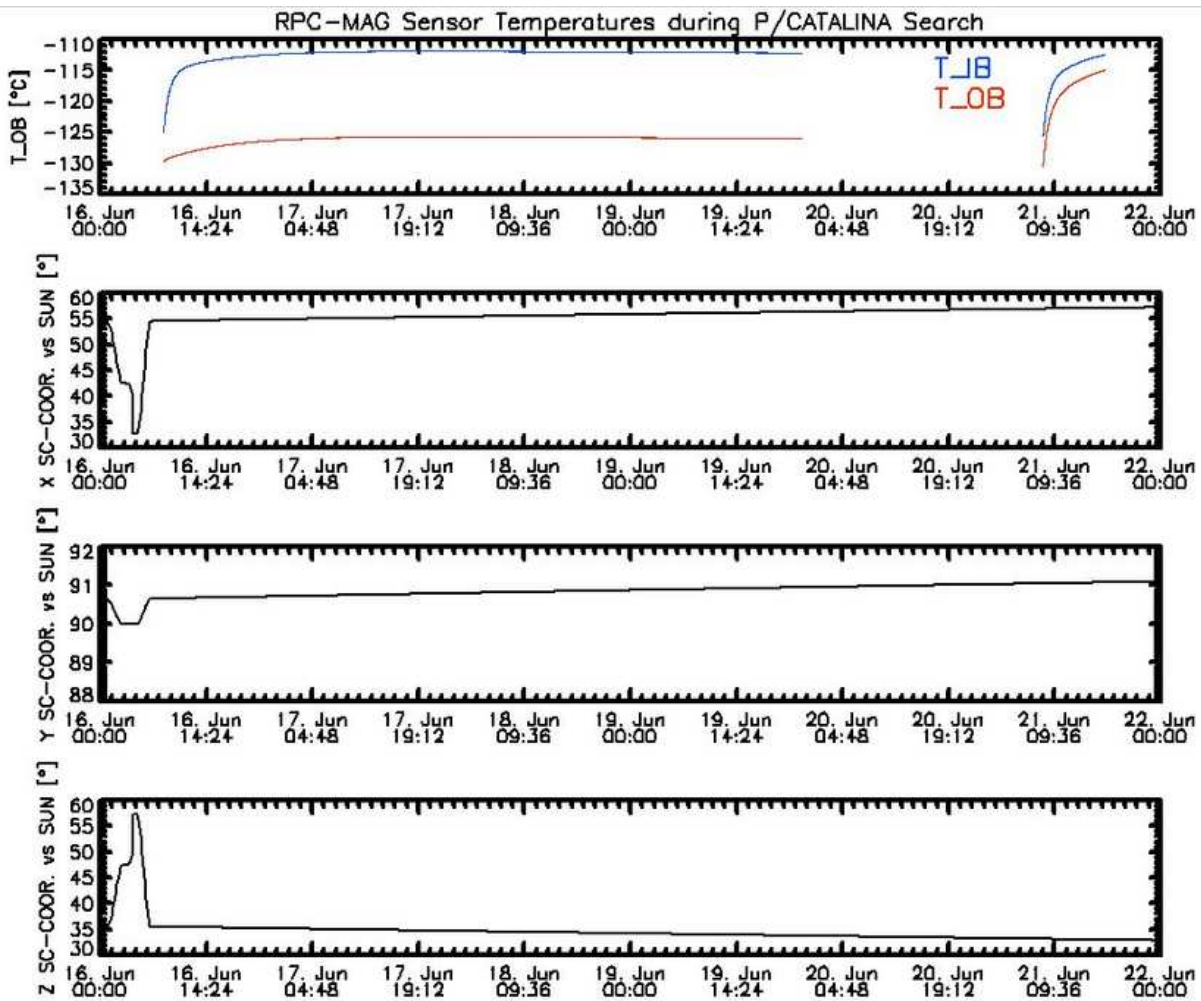

Figure 17: RPCMAG: Sensor Temperatures

ROSETTA

IGEP Institut für Geophysik u. extraterr. Physik
Technische Universität Braunschweig

Document: RO-IGEP-TR-0015
Issue: 1
Revision: 2
Date: August 3, 2005
Page: 21

G RFW for Thermal Tests



REQUEST FOR WAIVER Rosetta Plasma Consortium		[0] RFW number:	RO-RPC-RW-				
Issue/Rev:		01/00	Date:	03 /01 /2001				
Equipment:	<input type="checkbox"/> 1: IES	<input type="checkbox"/> 2: ICA	<input type="checkbox"/> 3: LAP	<input type="checkbox"/> 4: MIP	<input checked="" type="checkbox"/> 5: MAG	<input type="checkbox"/> 6: PIU	<input type="checkbox"/> 7: EGSE	<input type="checkbox"/> 8: other
Unit:		Model:	<input type="checkbox"/> BB	<input type="checkbox"/> STM	<input checked="" type="checkbox"/> EQM	<input checked="" type="checkbox"/> FM	<input checked="" type="checkbox"/> FS	
Related NCR (if any):								
[1] Title of Request: Modified Thermal Vacuum Test Procedure for RPC-MAG Sensors 5.1,5.2 Qualification and Acceptance Test								
[2] Affected End Items: RPC-MAG Sensors -5.1,-5.2								
[3] Requirements / Interface Documents affected: EID -A sect.4.4.10								
[4] Description of Deviation: 1. For the negative boom sensors temperature range it is impossible to run in magnetic controlled environment and down to -160C in any vacuum chamber. We only run this test in air in a Mumetal chamber for the negative T-range. 2. We were unable to perform 8 cycles (Qualification) and 4 cycles (Acceptance) from room temperature to -160C. We only could run 2 ½ cycles because of facility-, liquid Nitrogen- and duration limitations.								
[5] Other items or requirements (potentially) affected: none								
[6] Need for RFW / Rationale for Acceptance: To control the proper operation of the MAG sensors during TV test this test has to be run under controlled magnetic environment .Because also the very small sensors(36g) contain only mechanical parts besides the Pt thermistor no vacuum is required. To test the maximum mechanical stresses caused by negative temperatures we have thrown the sensors into liquid nitrogen as a maximum thermal shock test!(- no failure). For qualification and Acceptance test we then performed two and a half cycles between room temperature and down to -192C (requested was -160C only for Qual)respectively down to -160C for 6! Sensors (FM,FS,FSS) with about 4 hours at minimum temperatures. We also performed several switch-ON/Off sequences. All tests went fine, no failure. The total number of cycles was limited because of liquid nitrogen available (400liter liquid nitrogen were consumed for these 2 1/2 cycles within 3.5 days.) and the only available chamber in Europe booking schedule.								
[7] Originator:	Name:	Signature:	Date:					
MAG TM	Guenter Musmann.		30/01/2001					
[8] Approvals / Rejection:	Name:	Signature:	Date:					
PI, TM:								
RPC:CM	G.Musmann		30.1.2001					
ESA RPO:								
Attachments:								
Distribution:								

Figure 18: Request for Waiver: Thermal Tests