



University of Bern
Institute of Physics
Space Research and Planetology

Rosetta - ROSINA

To Planetary Science Archive Interface Control
Document

RO-ROS-MAN-1039

Issue 1.9

21-March-16

Kathrin Altwegg

Prepared by: Instrument Archive Responsible

Approved by: Principal Investigator



TBD ITEMS

Section	Description
2.5.8	Derived and other Data Products

Change Record

Issue	Date	Change	Responsible
Issue 1.2	20.June06	3.1.2	Altwegg
Issue 1.3	12 October06	1.7 Acronyms and abbreviations in alphabetic order 3.1.2 change raw data set name 3.1.4 change TIME definition 3.4.3.7 change images format 4.3 change all samples of labels 4.4 update of the labels definition	Sémon
Issue 1.4	02 May07	2.5.6 Update Software paragraph 2.5.7 Add available documents Clarify COPS PDS structure and timestamp values calculation (4.3.2, 4.4.5.1) Update LABEL files structure Delete DEOMETRY directory Correct Catalog files name	Sémon
Issue 1.4	02 May07	Add COPS from DDS to gas flow characteristics in chapter 2.4.3 / 2.4.4	Altwegg
Issue 1.5	02 October07	1.5 Update paragraph content Complete Acronyms and Abbreviations Add DATA_QUALITY_ID and DATA_QUALITY_DESC (§4.4.3) Add NOTE keyword in the Descriptive Data Elements chapter (§4.4.4)	Sémon
Issue 1.6	29 October08	New COPS Science definition Update content in File Naming Convention, Data Directory Naming Convention and COPS Science EDR Data Product Design paragraphs.	Sémon
Issue 1.6b	25. November09	Clarification with respect to calibration	Altwegg
Issue 1.7	24 December09	Add Mass scale calculation, cancel	Sémon



ROSINA - EAICD

Document No. : RO-ROS-MAN-1039
Issue/Rev. No. : 1.82
Date : 21 March 2016
Page : 4

		Software directory paragraph	
Issue 1.8	19 April10	Add NG, RG, BG acronyms	Sémon
Issue 1.9	21 March16	Update FM acronyms Update of the Raw Data Records, Reduced Data Records and Derived Data Records Update "Data Product Design and Sample Labels – CODMAC L2" paragraph Add "Data Product Design and Sample Labels – CODMAC L3" paragraph Add "Reference Frames" paragraph	Sémon



Table Of Contents

1	Introduction	8
1.1	Purpose and Scope	8
1.2	Archiving Authorities	8
1.1.1	ESA’s Planetary Science Archive (PSA).....	8
1.3	Contents	8
1.4	Intended Readership.....	9
1.5	Applicable Documents	9
1.6	Relationships to Other Interfaces.....	9
1.7	Acronyms and Abbreviations.....	9
1.8	Contact Names and Addresses.....	10
2	Overview of Scientific Objectives, Instrument Design, Data Handling Process and Product Generation	11
2.1	General.....	11
2.2	Scientific Objectives.....	13
2.2.1	Scientific Goals.....	14
2.2.2	Scientific Closure	15
2.3	Instrument design	17
2.3.1	DFMS	17
2.3.2	RTOF	18
2.3.3	COPS	19
2.4	Data handling process.....	20
2.4.1	From DDS to PDS	20
2.4.2	From PDS to mass spectra	21
2.4.3	From mass spectra to density profiles.....	22
2.4.4	From density profiles to parent molecules and to the nucleus composition	23
2.5	Overview of Data Products	24
2.5.1	Pre-Flight Data Products.....	24
2.5.2	Sub-System Tests	24
2.5.3	Instrument Calibrations	24
2.5.4	Other Files written during Calibration.....	26
2.5.5	In-Flight Data Products.....	26
2.5.6	Software.....	26
2.5.7	Documentation.....	27
2.5.8	Derived and other Data Products	28
2.5.9	Ancillary Data Usage.....	28
3	Archive Format and Content	29
3.1	Format and Conventions	29
3.1.1	Deliveries and Archive Volume Format	29
3.1.2	Data Set ID Formation	29
3.1.3	Data Directory Naming Convention	31
3.1.4	File Naming Convention.....	31



3.2	Standards Used in Data Product Generation	32
3.2.1	PDS Standards	32
3.2.2	Time Standards	32
3.2.3	Reference Systems	32
3.2.4	Reference Frames	32
3.2.5	Other Applicable Standards	32
3.3	Data Validation	33
3.4	Content.....	34
3.4.1	Volume Set	34
3.4.2	Data Set	34
3.4.3	Directories	34
4	Detailed Interface Specifications	36
4.1	Structure and Organization Overview.....	36
4.2	Data Sets, Definition and Content	36
4.3	Data Product Design and Sample Labels – CODMAC L2.....	36
4.3.1	COPS NG EDR Data Product Design	36
4.3.2	COPS SN EDR Data Product Design	37
4.3.3	COPS SR EDR Data Product Design	39
4.3.4	DFMS FA EDR Data Product Design	42
4.3.5	DFMS MC EDR Data Product Design	43
4.3.6	RTOF OS EDR Data Product Design.....	45
4.4	A label in a close view – CODMAC L2	46
4.4.1	File Characteristics Data Elements	46
4.4.2	Data Object Pointers Identification Data Elements	46
4.4.3	Identification Data Elements	47
4.4.4	Descriptive Data Elements	47
4.4.5	Data Object Definitions	48
4.4.6	Parameters Index File Definition.....	55
4.4.7	Mission Specific Keywords – CODMAC L2	56
4.5	Data Product Design and Sample Labels – CODMAC L3.....	57
4.5.1	COPS NG RDR Data Product Design	57
4.5.2	COPS SN RDR Data Product Design.....	58
4.5.3	COPS SR RDR Data Product Design.....	60
4.5.4	DFMS CE RDR Data Product Design.....	63
4.5.5	DFMS FA RDR Data Product Design.....	64
4.5.6	DFMS MC RDR Data Product Design.....	66
4.5.7	RTOF OS RDR Data Product Design.....	68
4.6	A label in a close view – CODMAC L3	70
4.6.1	File Characteristics Data Elements	70
4.6.2	Data Object Pointers Identification Data Elements	70
4.6.3	Identification Data Elements	71
4.6.4	Descriptive Data Elements	71
4.6.5	Data Object Definitions	72
4.6.6	Parameters Index File Definition.....	83
4.6.7	Mission Specific Keywords – CODMAC L3	83



ROSINA - EAICD

Document No. : RO-ROS-MAN-1039
Issue/Rev. No. : 1.82
Date : 21 March 2016
Page : 7



1 Introduction

1.1 Purpose and Scope

The purpose of this EAICD (Experimenter to (Science) Archive Interface Control Document) is two fold. First it provides users of the ROSINA instrument with detailed description of the product and a description of how it was generated, including data sources and destinations. Secondly, it is the official interface between your instrument team and your archiving authority.

1.2 Archiving Authorities

The Planetary Data System Standard is used as archiving standard by

- NASA for U.S. planetary missions, implemented by PDS
- ESA for European planetary missions, implemented by the Research and Scientific Support Department (RSSD) of ESA

1.1.1 *ESA's Planetary Science Archive (PSA)*

ESA implements an online science archive, the PSA,

- to support and ease data ingestion
- to offer additional services to the scientific user community and science operations teams as e.g.
 - search queries that allow searches across instruments, missions and scientific disciplines
 - several data delivery options as
 - direct download of data products, linked files and data sets
 - ftp download of data products, linked files and data sets

The PSA aims for online ingestion of logical archive volumes and will offer the creation of physical archive volumes on request.

1.3 Contents

This document describes the data flow of the ROSINA instrument on Rosetta from the s/c until the insertion into the PSA for ESA. It includes information on how data were processed, formatted, labeled and uniquely identified. The document discusses general naming schemes for data volumes, data sets, data and label files. Standards used to generate the product are explained. Software that may be used to access the product is explained further on.

The design of the data set structure and the data product is given. Examples of these are given in the appendix.



1.4 Intended Readership

The staff of the archiving authority (Planetary Science Archive, ESA, RSSD, design team) and any potential user of the ROSINA data. However, it is not intended that people not familiar with the ROSINA sensors and with mass spectrometry are able, based solely on this document and the archived data, to work with ROSINA raw data. This instrument is by far too complex to be understood by laymen. Raw data depend on too many parameters hidden in the housekeeping data to be of any value to the general public. In order to work with raw data one has to familiarize himself with the complete user manual (including the annexes) and one has to be knowledgeable in the field of mass spectrometry.

1.5 Applicable Documents

Planetary Data System Preparation Workbook, February 1, 1995, Version 3.1, JPL, D-7669, Part1

Planetary Data System Standards Reference, Aug. 2003, Version 3.6, JPL, D-7669, Part 2
Rosetta Archive Generation, Validation and Transfer Plan, [October 6, 2005]

ROSINA Users Manual (RO-ROS-Man-1009, Version 3.0) including annexes

1.6 Relationships to Other Interfaces

N/A

1.7 Acronyms and Abbreviations

List of Acronyms

AU	Astronomical units
BG	Both Gauges (Nude & Ram gauges)
CEM	Channel electron multiplier
CNES	Centre national d'étude spatiale
COPS	Cometary pressure sensor
DDR	Derived Data Record (Processed and evaluated data)
DDS	Data delivery system
DFMS	Double focusing mass spectrometer
DPU	Digital Processing Unit
DTS	Delayed time sampling mode
D/H	Deuterium / hydrogen
EDR	Edited Data Record (Raw data)
ESOC	European space operation center
ETS	Equivalent time sampling system
ETSL	Equivalent time sampling system light
FAR	Faraday cup
FM	Flight model, has NOT flown, is currently in the laboratory used for additional ground-calibration
FS	Flight spare model, model flown on Rosetta
HIRM	High resolution mode
HK	Housekeeping
IMS	Ion mass spectrometer



I/F	Interface
LEDA	Linear electron detector array
MCP	Multi channel plate
m/q	Masse / charge
NG	Nuder Gauge
OS	Orthogonal source
PDS	Planetary data system
PSA	Planetary Science Archive
PVV	PSA Volume Verifier
RDR	Reduced Data Record (Calibrated data)
RG	Ram Gauge
RTOF	Reflectron type time of flight sensor
SS	Storage source
TF	Time Focus
UoB	University of Bern

1.8 Contact Names and Addresses

Kathrin Altwegg, Physikalisches Institut, University of Bern, Sidlerstr. 5, CH-3012 Bern

e-mail: altwegg@phim.unibe.ch

Tel.: (+41) 31 631 4420

Fax: (+41) 31 631 4405

Timm Riesen, Physikalisches Institut, University of Bern, Sidlerstr. 5, CH-3012 Bern

e-mail: riesen@phim.unibe.ch

Tel.: (+41) 31 631 4415

Fax: (+41) 31 631 4405

Thierry Sémon, Physikalisches Institut, University of Bern, Sidlerstr. 5, CH-3012 Bern

e-mail: semon@phim.unibe.ch

Tel.: (+41) 31 631 4425

Fax: (+41) 31 631 4405



2 Overview of Scientific Objectives, Instrument Design, Data Handling Process and Product Generation

2.1 General

The Rosetta Orbiter Spectrometer for Ion and Neutral Analysis (ROSINA) will answer outstanding questions concerning the main objectives of the Rosetta mission. To accomplish the very demanding objectives, ROSINA will have unprecedented capabilities, including very wide mass range from 1 amu to >300 amu; very high mass resolution (ability to resolve CO from N₂ and ¹³C from ¹²CH), very wide dynamic range and high sensitivity; the ability to determine cometary gas, velocities, and temperature. The necessities for these capabilities stems from the requirements to monitor the comet during the whole mission through all different phases of activities. Three sensors are needed to accomplish the science objectives.

INSTRUMENT REQUIREMENTS

Table 1 lists the science objectives and the instrument requirements necessary to achieve them. The necessary performance of ROSINA is summarized in table 2 and the comparison of operating ranges of the two mass analyzers is given in fig. 2.1. The requirements listed in Table 1 are unprecedented in space mass spectrometry. So far, no single instrument is able to fulfill all of these requirements. We have therefore adopted a three-sensor approach: each sensor is optimized for part of the scientific objectives while at the same time complementing the other sensors. In view of the very long mission duration they also provide the necessary redundancy.

Sensor I (DFMS) is a double focusing magnetic mass spectrometer with a mass range 1- 100 amu and a mass resolution of 3000 at 1 % peak height. This sensor is optimized for very high mass resolution and large dynamic range.

Sensor II (RTOF) is a reflectron type time of flight mass spectrometer with a mass range 1->300 amu and a high sensitivity. The mass resolution is better than 500 at 1 % peak height. This sensor is optimized for high sensitivity over a very broad mass range.

Sensor III (COPS) consists of two pressure gauges providing density and velocity measurements of the cometary gas.

Table 2.1 Science objectives and measurement requirements for ROSINA

Scientific Objectives	Associated critical measurements	Measurement requirements
Determine elemental abundances in the	Separate CO from N ₂	Mass resolution >2500 at 1 % of peak height at mass 28



ROSINA - EAICD

Document No. : RO-ROS-MAN-1039
 Issue/Rev. No. : 1.82
 Date : 21 March 2016
 Page : 12

gas		amu
Determine molecular composition of volatiles	Measure and separate heavy hydrocarbons (neutrals and ions) up to mass 300 amu	Mass range 1-300 amu with a resolution of >300 at 1 %; Sensitivity >10 ⁻³ A/Torr
Determine isotopic composition of volatiles	Separate ¹² CH and ¹³ C. Measure HDO, DCN and other deuterated neutrals and ions	Mass resolution >3000 at 1 % peak height, relative accuracy 1 %, absolute accuracy 10 %
Study the development of the cometary activity	Measure the composition (water and minor constituents) between 3.5 AU (gas production rate 10 ²⁴ s ⁻¹) and perihelion (10 ²⁹ s ⁻¹)	Mass range 1-300 amu, dynamic range 10 ⁸
Study the coma chemistry and test existing models	Measure ions and molecules in the mass range 1-300 amu and their velocity and temperature	Mass range for ions and neutrals 1- >300 amu, dynamic range 10 ⁸ sensitivity >10 ⁻³ A/Torr
Study the gas dynamics and the interaction with the dust	Measurement of the bulk velocity and temperature of the gas	Bulk velocity corresponding to E=0.02 eV <input type="checkbox"/> 10 %, temperature = 0.01 eV <input type="checkbox"/> 20%
Characterization of the nucleus	Characterization of outbursts and jets of limited angular extent	2° Narrow field of view, time resolution =1 minute
Characterization of asteroids	Detect asteroid exosphere or determine upper limit	Extreme sensitivity for H ₂ O, CO, and CO ₂

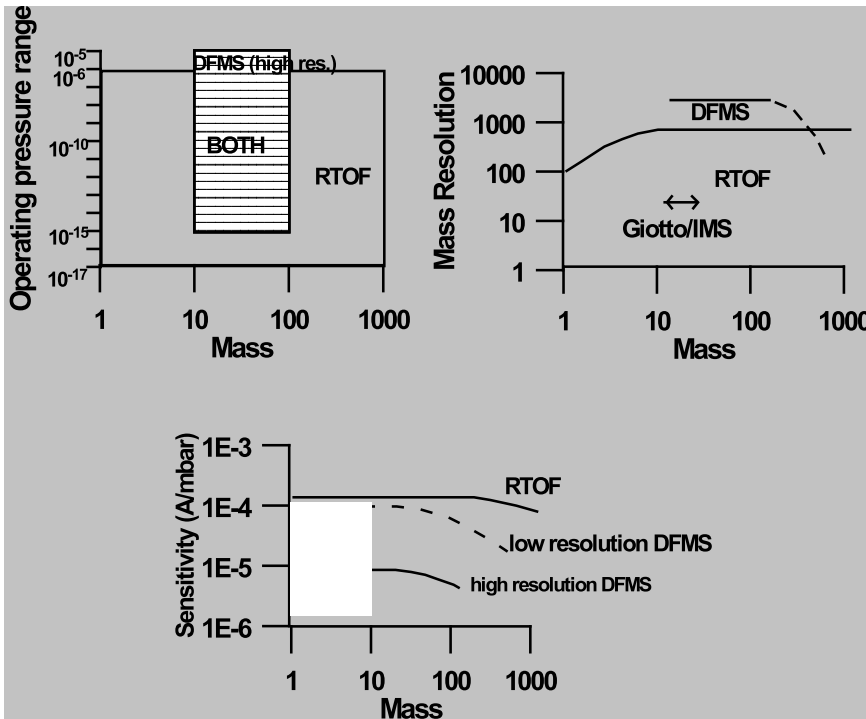

Fig. 2.1 Comparison of the operating ranges of DFMS and RTOF

2.2 Scientific Objectives

Comets are believed to be the most pristine bodies in the solar system. They were created 4.6 billion years ago far away from the sun and have stayed for most of the time of their existence far outside of Pluto. They are small enough to have experienced almost no internal heating. They therefore present a reservoir of well-preserved material from the time of the creation of the solar system. They can present clues to the origin of the solar system material and to the processes which led from the solar nebula to the formation of planets. Some of the material present in comets can even be traced back to the dark molecular cloud from which our solar system emerged (e.g. Irvine, 1999). In contrast to meteorites, the other primitive material available for investigations, comets have maintained the volatile part of the solar nebula.

Several interesting questions on the history of the solar system materials can therefore only be answered by studying comets, and in particular by studying the composition of the volatile material which is the main goal of the ROSINA instrument. Below is a list of measurements still to be made and the associated topics that can benefit from it. The list is certainly incomplete and will evolve with time.

Elemental abundances:

- Nitrogen abundance: Physical and chemical conditions during comet formation;
- Noble gases: Processing of comets



Isotopic abundances:

- D/H in heavy organic molecules: Origin of material
- Other isotopes in different molecules (C, O etc.): Origin of material

Molecular abundances:

- Heavy organic molecules: Origin of material; processing of material prior to incorporation in comets
- Reduced vs. oxidized molecules: Chemical and physical conditions during molecule formation; origin of material
- Series of molecules, e.g. C_nH_m : Origin of material; processing of material prior to incorporation in comets
- O_2 , O_3 : Origin of terrestrial oxygen
- Radicals : Physical and chemical conditions during comet formation; processing of comets

Physical and chemical processes:

- Extended Sources: Composition of dust in the coma;
- Molecular abundances as function of heliospheric distance: Nucleus composition, and processing of nucleus
- Molecular abundance differences in jets: Homogeneity of nucleus composition; spatial and temporal differences
- Abundance differences between Oort cloud comets and Kuiper belt comets: Physical and chemical conditions in the different comet forming regions; chemistry in the solar nebula and sub-nebulae

2.2.1 Scientific Goals

As part of the core payload of the Rosetta mission, the Rosetta Orbiter Spectrometer for Ion and Neutral Analysis (ROSINA) will answer outstanding questions concerning the main objectives of the mission. The primary measurement objective of the spectrometer is:

- To determine the elemental, isotopic and molecular composition of the atmospheres and ionospheres of comets as well as the temperature and bulk velocity of the gas and the homogenous and inhomogeneous reactions of gas and ions in the dusty cometary atmosphere and ionosphere.

In determining the composition of the atmospheres and ionospheres of comets, the following prime scientific objectives, also defined by the Rosetta Science Definition Team will be achieved:

- Determination of the global molecular, elemental, and isotopic composition and the physical, chemical and morphological character of the cometary nucleus.
- Determination of the processes by which the dusty cometary atmosphere and ionosphere are formed and to characterize their dynamics as a function of time, heliocentric and cometocentric position.
- Investigation of the origin of comets, the relationship between cometary and interstellar material and the implications for the origin of the solar system.



- Investigation of possible asteroid outgassing and establish what relationships exist between comets and asteroids.

To accomplish these very demanding objectives, ROSINA must have unprecedented capabilities, including:

- 1) Very wide mass range from 1 amu (Hydrogen) to >300 amu (organic molecules).
2) Very high mass resolution (ability to resolve CO from N2 and 13C from 12CH).
3) Very wide dynamic range and high sensitivity to accommodate very large differences in ion and neutral gas concentrations and large changes in the ion and gas flux as the comet changes activity between aphelion and perihelion.
4) The ability to determine the outflowing cometary gas flow velocities.

The necessity for the unusual high capabilities of this experiment stems from the fact that it is one of the key instruments which is able to give meaningful data during the whole mission and thus by monitoring and characterizing the different phases of comet activity from apogee through perigee will lead to a full understanding of cometary behavior. Correlated studies with optical observations, with, for example, the dust instruments, the magnetometer and the surface science package further augment the scientific return of the ROSINA instrument.

2.2.2 Scientific Closure

Table 2.3 shows the data products from the ROSINA investigation and the corresponding scientific objectives that will be addressed using these data products. In addition to the specific science objectives of ROSINA listed in the table, the data products will provide key information for additional science objectives of other Rosetta orbiter and lander instruments. Collaboration between the ROSINA investigation and other orbiter and lander investigations will greatly enhance the scientific results in several key areas including: dust-gas interaction, gas-plasma interaction, causes of cometary activity, and compositional differences within the nucleus.

Tabl 2.3. ROSINA sensors, data products and science objectives. .

Table with 3 columns: Sensor, Data Product, and Science Objective. It details the DFMS/RTOF sensor's data products and their corresponding scientific objectives.



ROSINA - EAICD

Document No. : RO-ROS-MAN-1039
Issue/Rev. No. : 1.82
Date : 21 March 2016
Page : 16

	- Detailed mapping of active and quiescent regions	Composition of the Nucleus compositional differences within the nucleus
COPS	Neutral Pressures, Velocities, Temperatures	Coma gas-dust dynamics

A complete understanding of the dust-gas interaction will require collaboration between ROSINA and the dust investigation. The comet produces approximately equal concentrations of gas and dust and there is a strong indication that this combination is responsible for extended sources such as CO in comet Halley. Extended observations of the comet by both ROSINA and the dust experiments will be exploited in a search for other extended gas sources and a complete characterization of the known extended sources and their origin within the dusty atmosphere.

Similarly, an understanding of the gas-plasma interaction will require collaboration between ROSINA and the plasma experiment. Basic quantities such as the gas production rate of the comet obtained from ROSINA will be important elements in the understanding of the plasma observations. Likewise, the plasma flow velocity, the electron temperature and the magnetic field will be important quantities for determining and checking the location of the contact surface near the comet when it is close to the sun. Low energy ion flow inside the contact surface is significantly affected by the presence of this barrier and its location will be important in interpreting the ROSINA ion observations.

A complete understanding of the causes of cometary activity and compositional differences within the nucleus will require collaboration between ROSINA and several orbiter and lander investigations. One important aspect to be investigated is the composition of volatiles measured by ROSINA and the composition of non-volatiles surface components measured by the lander. A cross-check of the relative composition of these two cometary components is required to completely account for cometary composition and to understand how (or if) the cometary coma differs from the evacuated material in the mantle. This combination of orbiter and lander composition measurements will be key in resolving the question of the ultimate fate of comets in the solar system.

Causes of cometary activity and compositional differences within the nucleus will also be investigated through a collaboration between ROSINA and other orbiter investigations. One important collaboration will be the coordinated mapping of cometary active regions with ROSINA, the camera investigations and the dust investigation. Possible compositional differences of the active regions will be measured directly with the narrow field of view part of the ROSINA DFMS. In coordination with camera and dust observations, these regions will be localized and identified. Possible compositional differences of each of these regions will be investigated periodically during the mission.



to determine if gas from these regions change with increasing cometary activity.

2.3 Instrument design

Table 2.2: ROSINA Performance

Component	Mass Range [amu]	Mass Resolution $m/\Delta m$ (at 1%)	Sensitivity Gas [A/Torr] (1)	Ion (2)	Dynamic Range (3)	Pressure Range [Torr] (4)	FOV	Highest time resolution for full spectrum
DFMS (5)	12-100	3000	10^{-5}	10^4	10^{10}	$10^{-5} - 10^{-15}$	$20^\circ \times 20^\circ$ $2^\circ \times 2^\circ$ (6)	120 s
RTOF	1- >300	>500	10^{-4}	10^3	$10^9/10^8$	$10^{-6} - 10^{-17}$	$10^\circ \times 40^\circ$	4 s / 5 min.
COPS			3×10^{-2}		10^6			10 sec.

- (1) 1×10^{-3} A/Torr corresponds to 0.2 counts/s if density is 1 cm^{-3} . Emission current of the ion source at $10 \mu\text{A}$, can be increased (up to a factor of 5) or decreased
- (2) Counts per second for cometary ion density of 1 cm^{-3}
- (3) Ratio of highest to lowest peak in one measurement cycle
- (4) Total measurement range
- (5) High resolution mode
- (6) Narrow field of view entrance

2.3.1 DFMS

The double focusing mass spectrometer is a state of the art high resolution Matauch - Herzog mass spectrometer (resolution $m/\Delta m > 3000$ at 1% peak height) with a high dynamic range and a good sensitivity see fig. 2.1). It is based on well-proven design concepts, which were optimized for mass resolution and dynamic range using modern methods for calculating ion optical properties. The main design goals are given in table 2.2.

The DFMS has two basic operation modes: a gas mode for analyzing cometary gases and an ion mode for measuring cometary ions. Switching between the gas and ion modes requires changing only a few potentials in the ion source and suppression of the electron emission that is used to ionize the gas. All other operations are identical for the two modes.

More information on modes can be found in the ROSINA users manual, especially in appendix AD1-Instrument modes DFMS.

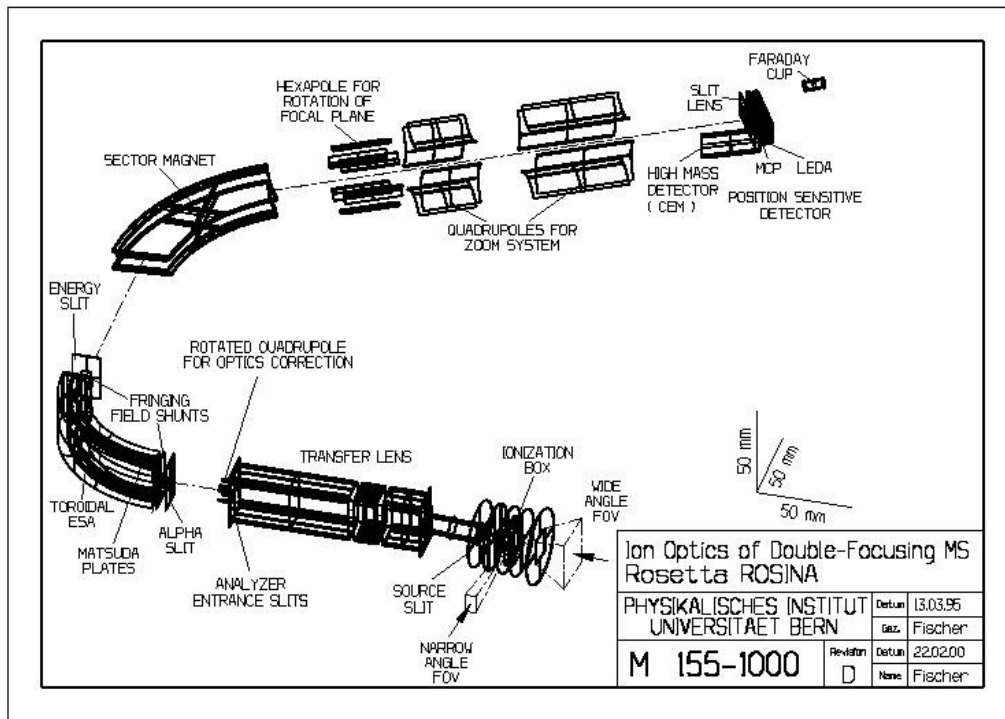

2.3.2 RTOF

The reflectron time-of-flight (RTOF) spectrometer was designed to complement the DFMS by extending the mass range and increasing the sensitivity of the full instrument package. TOF instruments have the inherent advantage that the entire mass spectra are recorded at once, without the need of scanning the masses through slits. With a storage ion source - a source that stores the continuously produced ions until their extraction into the TOF section - with high transmission in the TOF section and with a sensitive detector, it is possible to record a very large fraction (>60%) of all ions produced in the ion source. These factors contribute to the overwhelming sensitivity of TOF instruments. Another reason to use TOF instruments in space science is their simple mechanical design (their performance depends on fast electronics rather than on mechanical tolerances) and easy operation. An RTOF-type instrument was successfully flown on the GIOTTO mission to measure atoms and molecules ejected from a surface during impact of fast cometary dust particles.

Fig. 2.2. shows the principle of the realized RTOF sensor. A time-of-flight spectrometer operates by simultaneous extraction of all ions from the ionisation region into a drift space such that ions are time-focused at the first time focus plane (TF) at the beginning of the drift section. The temporal spread of such an ion packet is compressed from about 800 ns at the exit of the ionisation region to about 3 ns (for mass = 28 amu/e) at the first time focus plane. These very short ion bunches are then imaged onto the detector by the isochronous drift section. Because different m/q bunches drift with different velocities, the length of the drift section determines the temporal separation of the bunches. If properly matched to the drift section, the reflectron establishes the isochrony of the ion-optical system. The mass resolution is determined by the total drift time and the temporal spread of the ion packets at the location of the detector. Unlike other types of spectrometers, TOF spectrometers have no limit to the mass range. In practice the mass range is limited by the size of the signal accumulation memory.

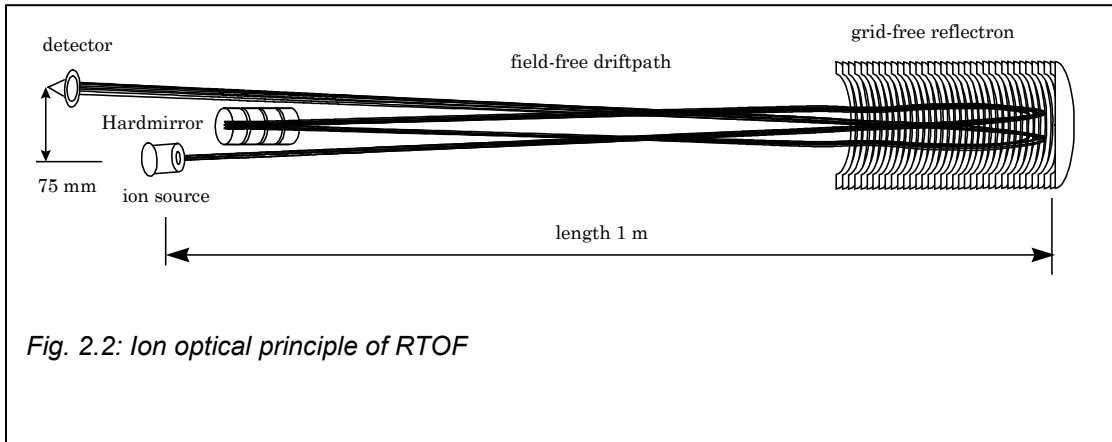

The ROSINA RTOF sensor includes two almost independent mass spectrometers in one common structure. The spectrometers share the principal ion-optical components, the reflectron and the hard mirror. The ion sources, the detectors and the data acquisition systems are separate. The electron impact storage ion source is dedicated to analysing neutral particles, and the orthogonal extraction ion source is assigned to analyse cometary ions. This configuration guarantees high reliability by almost complete redundancy. More information on modes can be found in the ROSINA users manual, especially in appendix AD2-RTOF Instrument modes.

2.3.3 COPS

The COPS (Comet Pressure Sensor) consists of two sensors based on the Bayard-Alpert ionisation gauge principle. The first gauge, called the « nude gauge » will measure the total pressure (more exactly the density) of the cometary gas. The second gauge, called the « ram gauge », will measure the ram pressure (equivalent to the cometary gas flux). From the two measurements, the expansion velocity and gas temperature can be derived. More information on modes can be found in the ROSINA users manual especially in AD3-COPS Instrument modes.

REMARK: The mode number is built with 3 digits, to make it compatible with the DFMS and RTOF modes definition, a leading "0" is added to the COPS modes (M0XXX).



2.4 Data handling process

2.4.1 From DDS to PDS

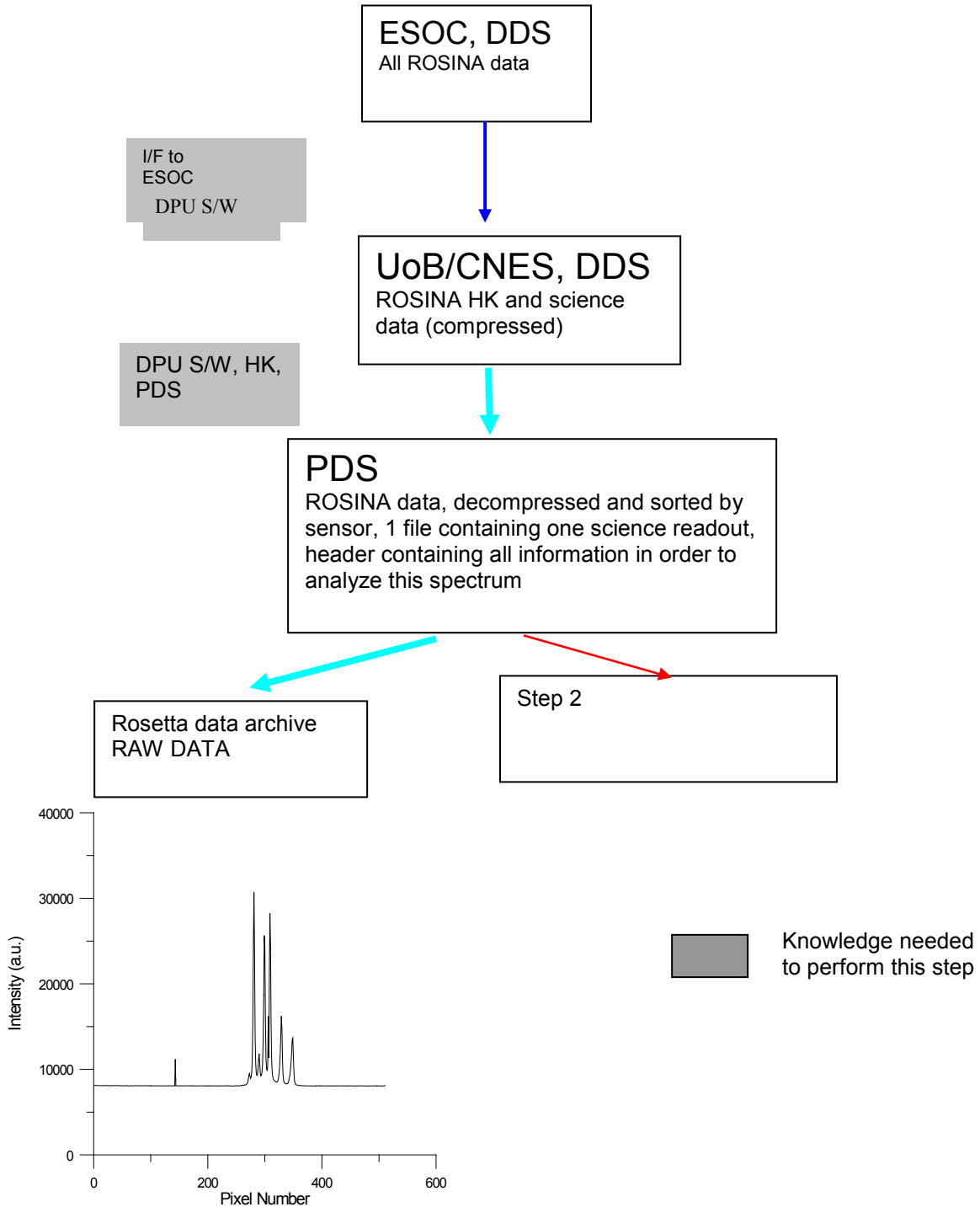



2.4.2 From PDS to mass spectra

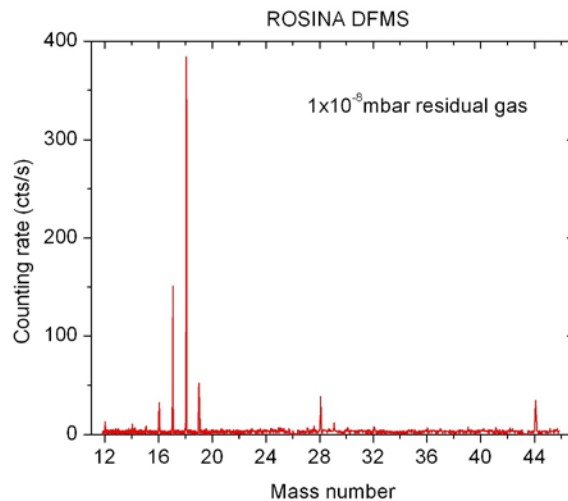
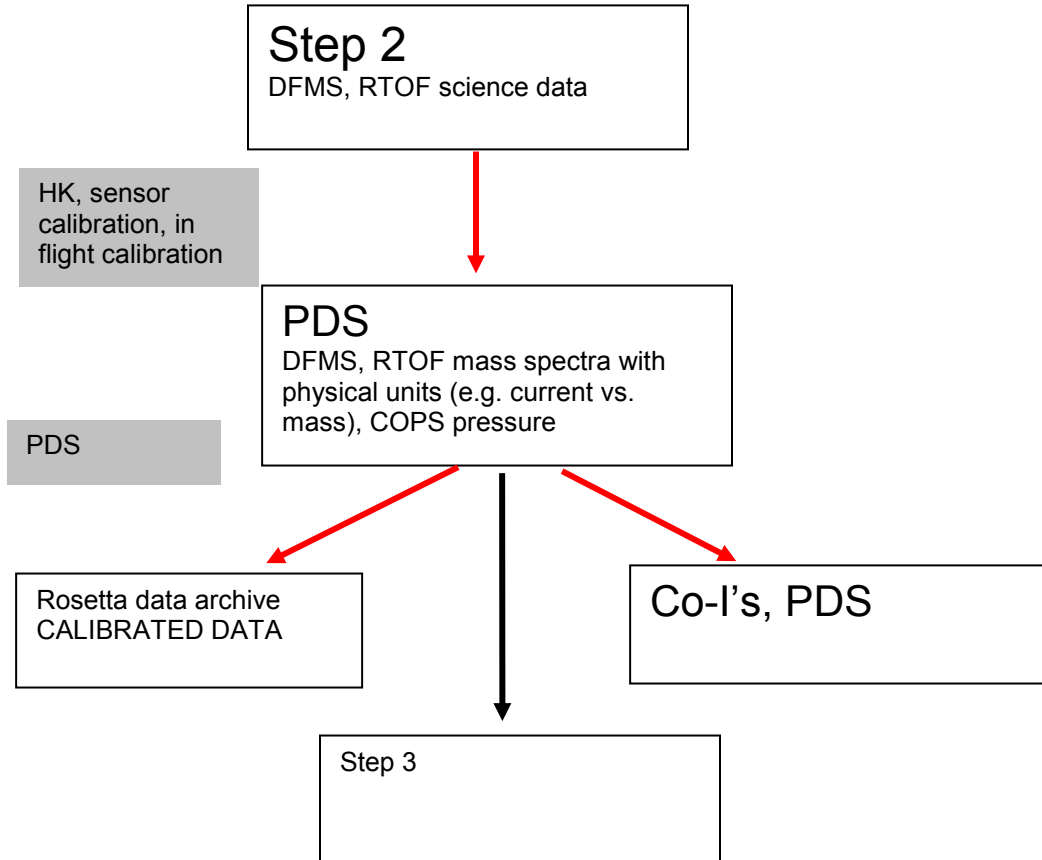



2.4.3 From mass spectra to density profiles

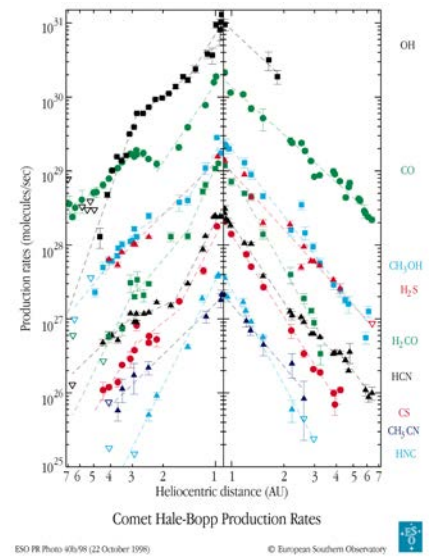
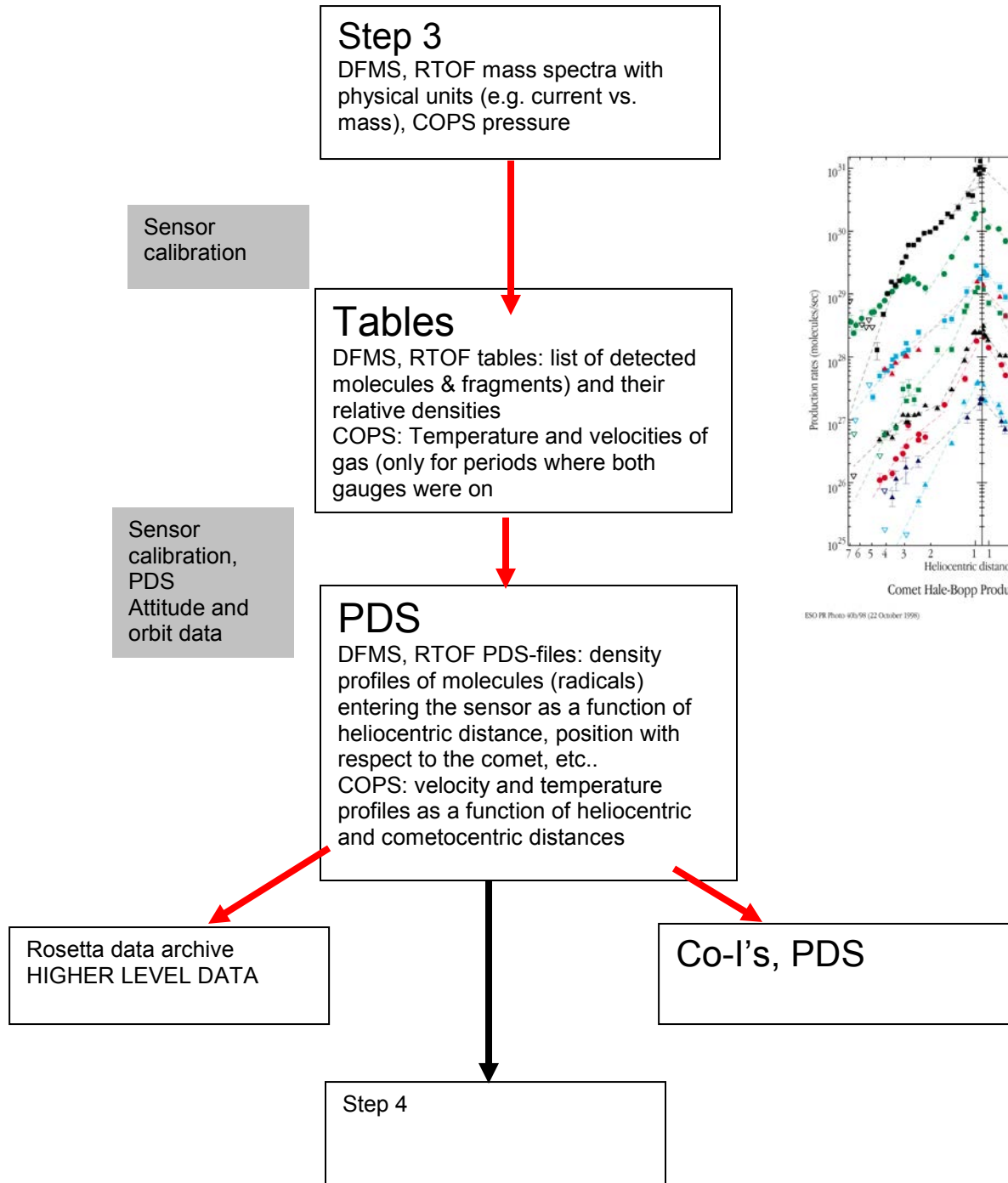



2.4.4 From density profiles to parent molecules and to the nucleus composition

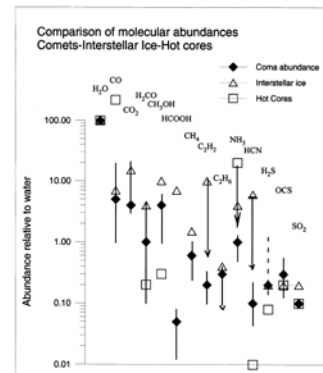
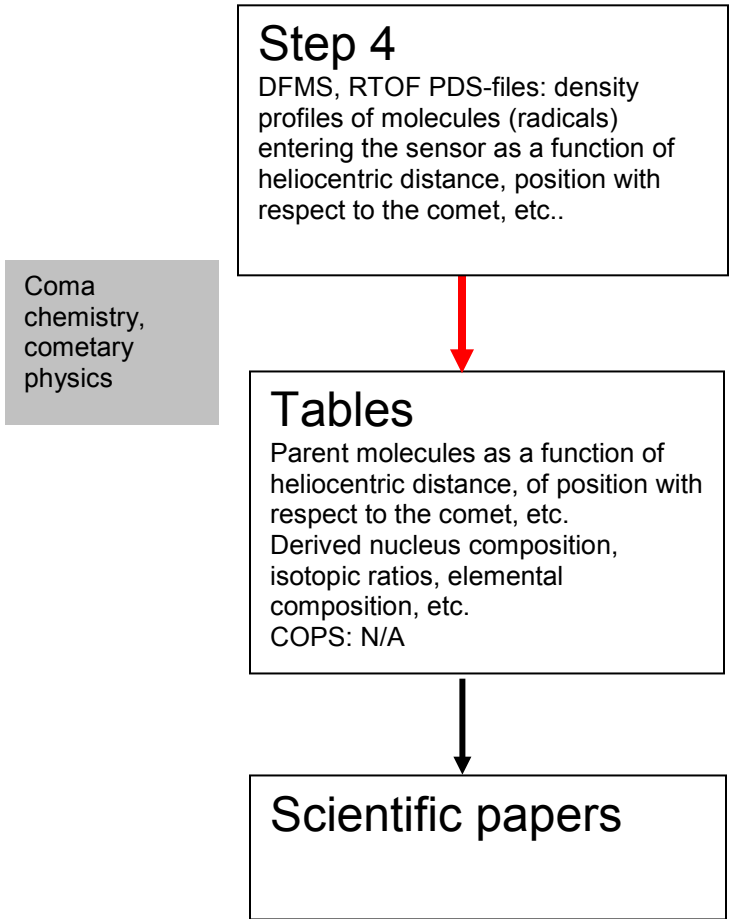



2.5 Overview of Data Products

2.5.1 *Pre-Flight Data Products*

N/A

2.5.2 *Sub-System Tests*

N/A

2.5.3 *Instrument Calibrations*

The FS model which is the model integrated on Rosetta has undergone a basic calibration (limited set of gases because of contamination). The FM model will undergo a complete calibration after launch, including the comet phases up till the end of the data analysis phase. Both sets of data will be archived as raw data and as higher level data (e.g. sensitivities, temperature dependence, gain curves of detectors, etc.) as soon as they are available.

There will be no calibration curves for the asteroid flybys unless there is a clear indication that there is an exosphere. Due to the high flyby velocity the normal calibration curves cannot be used. The amount of work needed to calibrate the sensors for this exceptional cases is not justified without a clear signature that an exosphere is present. The algorithm which can be used to calibrate the massscale of both RTOF and DFMS are described in the annexes to the user manual (DFMS operation manual AD1_INST_OP_DFMS.PDF, RTOF operation manual AD2_INST_OP_RTOF.PDF).

COPS has been calibrated with respect to N₂ gas. The pressure values given in the data therefore have to be corrected once the composition of the gas is known from DFMS and/or RTOF. The sensitivities for other gases will be given in the calibration data set once this is available.



2.5.3.1 Mass scale calculation for DFMS MC

$$m(px) = \exp(px - px_0) * 2e-4(\text{zoom}) * m_0$$

with m_0 : commanded mass (ROSINA_DFMS_SCI_MASS)
 px_0 : pixel, on which the nominal mass falls (can be obtained from known masses, especially inflight gas calibration modes, beware: px_0 is slightly temperature dependent!)
 $zoom$: =1 for low resolution, =6.2 for high resolution, resolution is defined by mode nr.
 px : actual pixel
 m : mass of actual pixel

2.5.3.2 Mass scale calculation for DFMS CE

$$m(\text{stp}) = m_0 - (\text{wdth}_0 * \sqrt{m_0}) / \text{stw} + (\text{stp} - 1) * m_0 / \text{stw}$$

with m_0 : central mass, corresponds to commanded mass(ROSINA_DFMS_SCI_MASS), but may be slightly shifted due to temperature effects, shift can be deduced from known masses, especially inflight gas calibration modes
 wdth_0 : total scan width/2; =140 for LR; = 280 for HR
 stw : =stepwidth; =4000 for LR and 40000 for HR
 stp : step number

2.5.3.3 Mass scale calculation for DFMS FA

$$m(\text{stp}) = m_0 - (\text{wdth}_0 * \sqrt{m_0}) / \text{stw} + (\text{stp} - 1) * m_0 / \text{stw}$$

with m_0 : central mass, corresponds to commanded mass(ROSINA_DFMS_SCI_MASS), but may be slightly shifted due to temperature effects, shift can be deduced from known masses, especially inflight gas calibration modes
 wdth_0 : total scan width/2; =140 for LR; N/A for HR
 stw : =stepwidth; =200 for LR and N/A for HR
 stp : step number

2.5.3.4 Mass scale calculation for RTOF

$$m(\text{chn}) = \text{const} * (\text{chn} * 1.5 - t_0)^2$$

with chn : channel number
 const and t_0 derived from (at least) two known mass peaks (m_1 and m_2 at channel chn_1 and chn_2) of the spectrum, temperatur dependent:

$$t_0 = (\sqrt{m_1/m_2} * \text{chn}_1 - \text{chn}_2) * 1.5 / (\sqrt{m_1/m_2} - 1)$$
$$\text{const} = m_1 / (\text{chn}_1 * 1.5 - t_0)^2$$



2.5.4 Other Files written during Calibration

N/A

2.5.5 In-Flight Data Products

ROSINA will take scientific data during the asteroid flybys and during all of the comet phases. The transmitted data will consists of:

- DFMS mass spectra (single masses, high resolution; multiple masses, low resolution, CEM scan mass spectra, Faraday scan mass spectra, all for ions or neutral gas)
- RTOF mass spectra (ortho- and storage source mass spectra, ions and/or neutral gas)
- COPS densities (nude gauge, ram gauge, normal mode as housekeeping values, scientific mode as science data, gas dynamics parameters)
- DFMS in-flight calibration data
- RTOF in-flight calibration data
- DFMS background data
- RTOF background data
- DFMS special mode data (scan of electron energy, scan of attraction grid voltage, MCP pixel scan, etc.)
- RTOF special mode data (scan of electron energy, scan of attraction grid voltage, HIRM and DTS modes (see ROSINA users manual), etc.)

Except the COPS housekeeping data which are already in physical units (pressure) the data transmitted are in raw format without meaningful units. In order to deduce physical data from raw data the pre-flight calibration of the FS model together with the calibration data of the FM model and the in-flight calibration and background data have to be used. The in-flight calibration will be done appr. once a week (TBC). Optimization of the instrument will also be done on a regular basis (appr. once a week) as well as extensive background measurements. The data evaluation has always to be based on the last in-flight calibration, background and optimization. Frequent updates of the calibration files will therefore be necessary.

The pressure measured by COPS is already distributed to other instruments in flight (service 19). COPS data transmitted in the HK channel can be used as is for a cross calibration within ROSINA as well as with other instruments. To deduce however gas dynamics from COPS data calibration data as well as scientific data from COPS need to be correlated.

2.5.6 Software

No software will be provided; up to hibernation Software will be provided for the comet mission phases to convert level 2 to level 3 data once the calibration data are available



ROSINA - EAICD

Document No. : RO-ROS-MAN-1039
Issue/Rev. No. : 1.82
Date : 21 March 2016
Page : 27

2.5.7 Documentation

We will provide user manuals with annexes and final calibration reports in the directory "DOCUMENT". The format of the primary documentation will be PDF and additionally ASCII with PNG graphics.



List of the available documents

<u>Document name</u>	<u>Content</u>
EAICD_RO_V1_9	ROSINA planetary science archive interface control version 1.9
ROSINA_USER_MAN_V3_1	ROSINA Users Manual version 3.1
AB_FLIGHT_OPS4_2A	ROSINA flight operations plan
AC_RN_RECOVERY	ROSINA Contingency Recovery Procedure
AD1_INST_OP_DFMS	DFMS Instrument Modes and Measurement Sequences
AD2_INST_OP_RTOF	RTOF Instrument Modes and Measurement Sequences
AD3_INST_OP_COPS	COPS Instrument Modes and Measurement Sequences
AD4_RN_HK_MONITORING	ROSINA housekeeping monitoring Tables
AE_DPU_FS_SW_OP_MAN	Digital Processing Unit FS software operations manual
AF2_DPU_HK_REPORTS_FS	FS Digital Processing Unit Housekeeping reports
AF3_DPU_CMD_DESC	Digital Processing Unit commands description
AF4_DPU_EVENT_REPORTS	Digital Processing Unit event reports
AF5_RO_MODE_CHANGES	ROSINA Mode changes commands
AF6_DPU_SCIENCE_FS	FS Digital Processing Unit Science data packets structure
COPS_MODE_DESC	COPS Modes description
DFMS_MODE_DESC	DFMS Modes description
RTOF_MODE_DESC	DFMS Modes description
OPERATION_LOGBOOK	Operation logbook and planning information

2.5.8 Derived and other Data Products

Currently, it is not planned to archive derived data products or data products from cooperation with other instruments. However, if there is a need from the scientific community to have such products this may be included at a later time.

2.5.9 Ancillary Data Usage

Orbit and attitude data will extensively be used during step 3 of the data analysis (see chapter 2.3) to derive density profiles for different molecules and radicals, to analyze COPS gas dynamics data and to make use of the narrow field of view mode of DFMS. This will be done by using SPICE.



3 Archive Format and Content

3.1 Format and Conventions

3.1.1 Deliveries and Archive Volume Format

The volumes are organized the standard way, one data set on one volume. Since it is not allowed to bundle several processing levels within one data set, we will produce separate volumes for EDR, RDR and DDR data. The volumes will be delivered by FTP.

EDR: Edited Data Record (Raw data)
RDR: Reduced Data Record (Calibrated data)
DDR: Derived Data Record (Processed and evaluated data)

3.1.2 Data Set ID Formation

At this moment we cannot foresee all possible data set names that we might use in the future. Instead of a complete list of ID and NAMES, we define a naming convention and provide some examples of current and future data set names.

The definition of processing level 2 defines data with edited telemetry. This is already done by ESOC before we receive it. For this CODMAC level the datasets contain data from all ROSINA sensors (if applicable).

Raw data which are only for engineering purposes (X in Data set ID) will not be calibrated and have no scientific meaning.

Raw Data Records, foreseen deliveries:

DATA_SET_ID	Approx. Delivery date	Remarks
RO-X-ROSINA-2-ENG-V1.0	Aug. 2007	
RO-A-ROSINA-2-AST1-V1.0	2010-04-22	
RO-A-ROSINA-2-AST2-V1.0	2015-05-12	
RO-C-ROSINA-2-PRL-V1.0	2015-07-19	
RO-C-ROSINA-2-ESC1-V1.0	2015-09-10	
RO-C-ROSINA-2-ESC2-V1.0	2015-12-30	
RO-C-ROSINA-2-ESC3-V1.0	2016-04-21	
RO-C-ROSINA-2-ESC4-V1.0	2016-06-31	
RO-C-ROSINA-2-EXT1-V1.0	2016	
RO-C-ROSINA-2-EXT2-V1.0	2017	
RO-C-ROSINA-2-EXT3-V1.0	2017	

Example for a raw data set name:

DATA_SET_NAME = "ROSETTA-ORBITER CHECK ROSINA 2 ENGINEERING V1.0"



The definition of processing level 3 defines data with physical units. This is detector current in Ampère vs. mass scale in amu/e (pressure in mbar normalized to nitrogen vs time for COPS). For this CODMAC level the datasets contain data from all ROSINA sensors (if applicable).

Calibrated data,

Reduced Data Records foreseen for delivery

DATA_SET_ID	Appr. Delivery date	Remarks
RO-A-ROSINA-3-AST1-V1.0	2018	
RO-A-ROSINA-3-AST2-V1.0	2018	
RO-C-ROSINA-3-PRL-V1.0	2018	
RO-C-ROSINA-3-ESC1-V1.0	2018	
RO-C-ROSINA-3-ESC2-V1.0	2018	
RO-C-ROSINA-3-ESC3-V1.0	2018	
RO-C-ROSINA-3-ESC4-V1.0	2018	
RO-C-ROSINA-3-EXT1-V1.0	2018	
RO-C-ROSINA-3-EXT2-V1.0	2018	
RO-C-ROSINA-3-EXT3-V1.0	2018	

The definition of processing level 5 defines derived data. This could include: abundance of parent molecules as a function of heliocentric distance of the comet; water density as a function of cometocentric distance, etc.

All instruments of ROSINA, Derived Data Records:

DATA_SET_ID*	Appr. Delivery date	Remarks
RO-A-ROSINA-5-AST1-YYY-V1.0	Optional, TBD	
RO-A-ROSINA-5-AST2-YYY-V1.0	Optional, TBD	
RO-C-ROSINA-5-PRL-YYY-V1.0	Optional, TBD	
RO-C-ROSINA-5-ESC1-YYY-V1.0	Optional, TBD	
RO-C-ROSINA-5-ESC2-YYY-V1.0	Optional, TBD	
RO-C-ROSINA-5-ESC3-YYY-V1.0	Optional, TBD	
RO-C-ROSINA-5-ESC4-YYY-V1.0	Optional, TBD	
RO-C-ROSINA-5-EXT1-YYY-V1.0	Optional, TBD	
RO-C-ROSINA-5-EXT2-YYY-V1.0	Optional, TBD	
RO-C-ROSINA-5-EXT3-YYY-V1.0	Optional, TBD	

*YYY: Sensors used to derive data, may have the values: "DFMS", "RTOF", "COPS", "DFMS/RTOF", "DFMS/COPS", "RTOF/COPS". If all sensors are used YYY is omitted.



3.1.3 Data Directory Naming Convention

The structure in the "DATA" directory is divided into several subdirectories. The first level differentiates the data from DFMS, RTOF and COPS. On the next level the subdirectories are named according to the detector of the particular instrument.

DFMS: MC for the MCP detector, CE for the CEM detector and FA for the FAR detector.

RTOF: OS for the Orthogonal Source and SS for the Storage Source.

COPS: NG for Nude Gauge, RG for Ram Gauge, BG for Both Gauges, SN for Science Mode – Nude Gauge and SR for Science Mode – Ram Gauge.

Both gauges means that the NG and the RG are operated together, both pressure values are in the same HK packet.

3.1.4 File Naming Convention

The file naming follows a strict rule. The filename consists of the following elements:

DETECTOR_DATE_TIME_INSTRUMENTMODE.EXTENTION

DETECTOR: MC, CE or FA; for DFMS
OS or SS; for RTOF
NG, RG; BG, SN or SR for COPS
DATE: DATE from DPU Timestamp in the format YYYYMMDD
YYYY (Year) MM (Month) DD (Day)
TIME: TIME from DPU Timestamp in the format HHMMSSsss
HH (Hour) MM (Minutes) SS (Seconds) sss (fractional milliseconds)
For CODMAC level 3, fractional milliseconds are replaced by “_3_”
INSTRUMENTMODE: Particular instrument mode according to HK in Science Packet
EXTENTION: TAB (File extension)

Example: CE_20141120_081042333_M0123.TAB

DFMS CEM file recorded on the 20. November 2014 at 08h 10m 42.333s during mode 123.



3.2 Standards Used in Data Product Generation

3.2.1 PDS Standards

The data products are generated according to the PDS standards. The files are in complete 7-bit ASCII and are easily human and machine readable. We use ASCII tables as primary objects and append them directly to the label files. (Attached label model.)

3.2.2 Time Standards

All time values like Spacecraft Event Times or DPU timestamps are formatted according to the PDS standards (section 7.1 of the PDS standards reference). For the calculation of geometry information (derived data) at a specific time, we use the adequate SPICE kernels (e.g. leap second kernel) and the corresponding libraries. The Times standards are detailed in the Rosetta Time Handling document, RO-EST-TN-3165, section 4.2.

3.2.3 Reference Systems

For special geometry information we will use SPICE reference frames, which have been defined for the different instruments in the ROSETTA instrument kernel. In most other cases the J2000 reference frame will be used.

3.2.4 Reference Frames

The reference frames used to generate the CODMAC level 2 and level3 products are described in the following document.

Scholten, F., Preusker, F., Jorda, L., and Hviid, S.,
Reference Frames and Mapping Schemes of Comet 67P/C-G,
RO-C-MULTI-5-67P-SHAPE-V1.0:CHEOPS_REF_FRAME_V1,
NASA Planetary Data System and ESA Planetary Science Archive, 2015.

3.2.5 Other Applicable Standards

In case that we will add software sources in C to the archive, we will use the ANSI C standard to facilitate cross platform compiling.

Other applicable standards are not foreseen at the moment.



3.3 Data Validation

Data validation is not yet defined in details. PDS tools and the recommended validation procedure will lead this process.



3.4 Content

3.4.1 Volume Set

N/A

3.4.2 Data Set

Data set names and IDs are defined in section 3.1.2 of this document along with the naming convention. One data set per volume, no bundling is planned so far.

3.4.3 Directories

3.4.3.1 Root Directory

The root directory of the data set is equal to the DATA_SET_ID keyword value. It contains the files AAREADME.TXT and VOLDESC.CAT.

3.4.3.2 Calibration Directory

According to the PDS standards this directory has to be named "CALIB". It contains the file CALINFO.TXT with information on calibration files in this directory which were used in the processing of the data or which are needed to understand the data. The directory is optional and will be completed at a later date.

3.4.3.3 Catalog Directory

It contains the PDS catalog files CATINFO.TXT, MISSION.CAT, INSTHOST.CAT, INSTRUMENT.CAT, DATASET.CAT, PERSONNEL.CAT, SOFTWARE.CAT, TARGET.CAT and REFERENCE.CAT. Since most of the required information is already available in the ROSINA manual, which is added to every volume, we will refer to it wherever applicable.

3.4.3.4 Index Directory

It contains the files INDXINFO.TXT, INDEX.LBL and INDEX.TAB with all the indices for all data products on the volume.



3.4.3.5 Label Directory

It contains several FMT files which are referenced by structure pointers in the label section of the data files.

The available label files are:

COPS_HK.FMT, COPS_DATA.FMT, DFMS_HK.FMT, DFMS_MC_DATA.FMT,
DFMS_CE_DATA.FMT, DFMS_FA_DATA.FMT, RTOF_HK.FMT and the RTOF_DATA.FMT.

3.4.3.6 Document Directory

Along with the DOCINFO.TXT, we will provide documents in the portable document format (PDF) format or in 7-bit ASCII. Inside the ASCII files, images are referenced and stored in extra files in PNG format.

3.4.3.7 Data Directory

It contains the data files with the attached labels. For naming and structure see 3.1.3.



4 Detailed Interface Specifications

4.1 Structure and Organization Overview

Most of the structure is already defined in earlier sections. This chapter will provide example of file contents and labels.

4.2 Data Sets, Definition and Content

See 2.4. A description of all the raw data (HK and scientific data) of the sensors can be found in the ROSINA users manual - appendix AD4.

4.3 Data Product Design and Sample Labels – CODMAC L2

Derived data products and model based data products are TBD. For other data products, several "designs" have been defined and are listed together with sample labels (attached data not included).

4.3.1 COPS NG EDR Data Product Design

This design applies for NG, RG and BG files.

```
PDS_VERSION_ID           = PDS3
LABEL_REVISION_NOTE      = "2007-09-27,Thierry Sémon(UoB),
                           version2.1 release;"
RECORD_TYPE              = FIXED_LENGTH
RECORD_BYTES             = 80
FILE_RECORDS             = 138
LABEL_RECORDS           = 69
^COPS_HK_TABLE           = 70
DATA_SET_ID              = "RO-X-ROSINA-2-ENG-V1.0"
DATA_SET_NAME            = "ROSETTA-ORBITER CHECK ROSINA 2
                           ENGINEERING V1.0"
PRODUCT_ID               = NG_20050706_093308315_M0322
PRODUCT_CREATION_TIME    = 2006-10-19T15:01:44.984
PRODUCT_TYPE             = EDR
PROCESSING_LEVEL_ID     = "2"
MISSION_ID               = ROSETTA
MISSION_NAME             = "INTERNATIONAL ROSETTA MISSION"
TARGET_NAME              = "CHECKOUT"
TARGET_TYPE              = "N/A"
MISSION_PHASE_NAME      = "COMMISSIONING"
INSTRUMENT_HOST_NAME     = "ROSETTA-ORBITER"
INSTRUMENT_HOST_ID      = RO
INSTRUMENT_NAME         = "ROSETTA ORBITER SPECTROMETER FOR
                           ION AND NEUTRAL ANALYSIS"
INSTRUMENT_ID           = ROSINA
INSTRUMENT_MODE_ID      = M0322
^INSTRUMENT_MODE_DESC   = "COPS_MODE_DESC.TXT"
INSTRUMENT_TYPE         = "MASS SPECTROMETER"
DETECTOR_ID             = COPS
```



```
DETECTOR_DESC = "COMET PRESSURE SENSOR"
CHANNEL_ID = NG
START_TIME = 2005-07-06T09:33:29.730
STOP_TIME = 2005-07-06T09:34:29.730
SPACECRAFT_CLOCK_START_COUNT = "1/79263188.315"
SPACECRAFT_CLOCK_STOP_COUNT = "1/79263248.315"
PRODUCER_ID = ROSETTA_ROSINA
PRODUCER_FULL_NAME = "KATHRIN ALTWEGG"
PRODUCER_INSTITUTION_NAME = "UNIVERSITY OF BERN"
DATA_QUALITY_ID = "N/A"
DATA_QUALITY_DESC = "N/A"
SC_SUN_POSITION_VECTOR = "N/A"
SC_TARGET_POSITION_VECTOR = "N/A"
COORDINATE_SYSTEM_ID = "N/A"
COORDINATE_SYSTEM_NAME = "N/A"
SC_TARGET_VELOCITY_VECTOR = "N/A"
SPACECRAFT_ALTITUDE = "N/A"
SUB_SPACECRAFT_LATITUDE = "N/A"
SUB_SPACECRAFT_LONGITUDE = "N/A"
DESCRIPTION = "This file contains results from the
Comet Pressure Sensor(COPS)
instrument flown aboard the ROSETTA
spacecraft during its mission to comet
67P/Churyumov-Gerasimenko."
NOTE = "
The EME J2000 reference frame is used for all position and
velocity vectors. Latitude and Longitude are PLANETOGRAPHIC
north latitudes and west longitudes. All values are computed
at t = START_TIME. Distances are given in <km>, velocities in
<km/s>, and angles in <deg>."
OBJECT = COPS_HK_TABLE
NAME = COPS_HOUSEKEEPING_TABLE
INTERCHANGE_FORMAT = ASCII
ROWS = 69
COLUMNS = 5
ROW_BYTES = 80
^STRUCTURE = "COPS_HK.FMT"
END_OBJECT = COPS_HK_TABLE
END
```

4.3.2 COPS SN EDR Data Product Design

The particularity of the COPS science structure is the COPS HK table composed by the 5 last standard COPS HK blocks followed by the last extended COPS HK block received by the DPU.

```
PDS_VERSION_ID = PDS3
LABEL_REVISION_NOTE = "2007-09-27,Thierry Sémon(UoB),
version2.1 release;"
RECORD_TYPE = FIXED_LENGTH
RECORD_BYTES = 80
FILE_RECORDS = 567
LABEL_RECORDS = 79
^COPS_HK_TABLE = 80
^COPS_SC_DATA_TABLE = 418
DATA_SET_ID = "RO-X-ROSINA-2-ENG-V1.0"
DATA_SET_NAME = "ROSETTA-ORBITER CHECK ROSINA 2
ENGINEERING V1.0"
PRODUCT_ID = SN_20050706_160107126_M0312
```



ROSINA - EAICD

Document No. : RO-ROS-MAN-1039
Issue/Rev. No. : 1.82
Date : 21 March 2016
Page : 38

```
PRODUCT_CREATION_TIME      = 2006-10-19T14:58:44.968
PRODUCT_TYPE               = EDR
PROCESSING_LEVEL_ID       = "2"
MISSION_ID                 = ROSETTA
MISSION_NAME               = "INTERNATIONAL ROSETTA MISSION"
TARGET_NAME                = "CHECKOUT"
TARGET_TYPE                = "N/A"
MISSION_PHASE_NAME        = "COMMISSIONING"
INSTRUMENT_HOST_NAME      = "ROSETTA-ORBITER"
INSTRUMENT_HOST_ID        = RO
INSTRUMENT_NAME           = "ROSETTA ORBITER SPECTROMETER FOR
                           ION AND NEUTRAL ANALYSIS"

INSTRUMENT_ID              = ROSINA
INSTRUMENT_MODE_ID        = M0312
^INSTRUMENT_MODE_DESC     = "COPS_MODE_DESC.TXT"
INSTRUMENT_TYPE           = "MASS SPECTROMETER"
DETECTOR_ID               = COPS
DETECTOR_DESC             = "COMET PRESSURE SENSOR"
CHANNEL_ID                 = SN
START_TIME                 = 2005-07-06T16:01:28.444
STOP_TIME                  = 2005-07-06T16:06:28.444
SPACECRAFT_CLOCK_START_COUNT = "1/79286467.126"
SPACECRAFT_CLOCK_STOP_COUNT = "1/79286767.126"
PRODUCER_ID                = ROSETTA_ROSINA
PRODUCER_FULL_NAME        = "KATHRIN ALTWEGG"
PRODUCER_INSTITUTION_NAME = "UNIVERSITY OF BERN"
DATA_QUALITY_ID           = "3"
DATA_QUALITY_DESC         = " Uncompressed or lossless compression"
SC_SUN_POSITION_VECTOR    = "N/A"
SC_TARGET_POSITION_VECTOR = "N/A"
COORDINATE_SYSTEM_ID      = "N/A"
COORDINATE_SYSTEM_NAME    = "N/A"
SC_TARGET_VELOCITY_VECTOR = "N/A"
SPACECRAFT_ALTITUDE       = "N/A"
SUB_SPACECRAFT_LATITUDE   = "N/A"
SUB_SPACECRAFT_LONGITUDE  = "N/A"
DESCRIPTION                 = "This file contains results from the
                           Comet Pressure Sensor(COPS)
                           instrument flown aboard the ROSETTA
                           spacecraft during its mission to comet
                           67P/Churyumov-Gerasimenko."

NOTE                        = "
The EME J2000 reference frame is used for all position and
velocity vectors. Latitude and Longitude are PLANETOGRAPHIC
north latitudes and west longitudes. All values are computed
at t = START_TIME. Distances are given in <km>, velocities in
<km/s>, and angles in <deg>."

OBJECT                      = COPS_HK_TABLE
  NAME                      = COPS_HOUSEKEEPING_TABLE
  INTERCHANGE_FORMAT        = ASCII
  ROWS                      = 338
  COLUMNS                  = 5
  ROW_BYTES                 = 80
  ^STRUCTURE                = "COPS_HK.FMT"
END_OBJECT                  = COPS_HK_TABLE

OBJECT                      = COPS_SC_DATA_TABLE
  NAME                      = COPS_DATA_TABLE
  INTERCHANGE_FORMAT        = ASCII
```



```
ROWS = 150
COLUMNS = 3
ROW_BYTES = 80
^STRUCTURE = "COPS_DATA.FMT"
END_OBJECT = COPS_SC_DATA_TABLE
END
```

4.3.3 COPS SR EDR Data Product Design

The particularity of the COPS science structure is the COPS HK table composed by the 5 last standard COPS HK blocks followed by the last extended COPS HK block received by the DPU.

```
PDS_VERSION_ID = PDS3
LABEL_REVISION_NOTE = "2007-09-27,Thierry Sémon(UoB),
                        version2.1 release;"
RECORD_TYPE = FIXED_LENGTH
RECORD_BYTES = 80
FILE_RECORDS = 567
LABEL_RECORDS = 79
^COPS_HK_TABLE = 80
^COPS_SC_DATA_TABLE = 418
DATA_SET_ID = "RO-X-ROSINA-2-ENG-V1.0"
DATA_SET_NAME = "ROSETTA-ORBITER CHECK ROSINA 2
                 ENGINEERING V1.0"
PRODUCT_ID = SR_20050706_160107126_M0312
PRODUCT_CREATION_TIME = 2006-10-19T14:58:44.968
PRODUCT_TYPE = EDR
PROCESSING_LEVEL_ID = "2"
MISSION_ID = ROSETTA
MISSION_NAME = "INTERNATIONAL ROSETTA MISSION"
TARGET_NAME = "CHECKOUT"
TARGET_TYPE = "N/A"
MISSION_PHASE_NAME = "COMMISSIONING"
INSTRUMENT_HOST_NAME = "ROSETTA-ORBITER"
INSTRUMENT_HOST_ID = RO
INSTRUMENT_NAME = "ROSETTA ORBITER SPECTROMETER FOR
                  ION AND NEUTRAL ANALYSIS"
INSTRUMENT_ID = ROSINA
INSTRUMENT_MODE_ID = M0312
^INSTRUMENT_MODE_DESC = "COPS_MODE_DESC.TXT"
INSTRUMENT_TYPE = "MASS SPECTROMETER"
DETECTOR_ID = COPS
DETECTOR_DESC = "COMET PRESSURE SENSOR"
CHANNEL_ID = SR
START_TIME = 2005-07-06T16:01:28.444
STOP_TIME = 2005-07-06T16:06:28.444
SPACECRAFT_CLOCK_START_COUNT = "1/79286467.126"
SPACECRAFT_CLOCK_STOP_COUNT = "1/79286767.126"
PRODUCER_ID = ROSETTA_ROSINA
PRODUCER_FULL_NAME = "KATHRIN ALTWEGG"
PRODUCER_INSTITUTION_NAME = "UNIVERSITY OF BERN"
DATA_QUALITY_ID = "3"
DATA_QUALITY_DESC = "Uncompressed or lossless compression"
SC_SUN_POSITION_VECTOR = "N/A"
SC_TARGET_POSITION_VECTOR = "N/A"
COORDINATE_SYSTEM_ID = "N/A"
COORDINATE_SYSTEM_NAME = "N/A"
SC_TARGET_VELOCITY_VECTOR = "N/A"
```



ROSINA - EAICD

Document No. : RO-ROS-MAN-1039
Issue/Rev. No. : 1.82
Date : 21 March 2016
Page : 40

SPACECRAFT_ALTITUDE = "N/A"
SUB_SPACECRAFT_LATITUDE = "N/A"
SUB_SPACECRAFT_LONGITUDE = "N/A"
DESCRIPTION = "This file contains results from the
Comet Pressure Sensor(COPS)
instrument flown aboard the ROSETTA
spacecraft during its mission to comet
67P/Churyumov-Gerasimenko."

NOTE = "
The EME J2000 reference frame is used for all position and
velocity vectors. Latitude and Longitude are PLANETOGRAPHIC
north latitudes and west longitudes. All values are computed
at t = START_TIME. Distances are given in <km>, velocities in
<km/s>, and angles in <deg>."

OBJECT = COPS_HK_TABLE
NAME = COPS_HOUSEKEEPING_TABLE
INTERCHANGE_FORMAT = ASCII
ROWS = 338
COLUMNS = 5
ROW_BYTES = 80
^STRUCTURE = "COPS_HK.FMT"
END_OBJECT = COPS_HK_TABLE

OBJECT = COPS_SC_DATA_TABLE
NAME = COPS_DATA_TABLE
INTERCHANGE_FORMAT = ASCII
ROWS = 150
COLUMNS = 3
ROW_BYTES = 80
^STRUCTURE = "COPS_DATA.FMT"
END_OBJECT = COPS_SC_DATA_TABLE
END



DFMS CE EDR Data Product Design

```
PDS_VERSION_ID = PDS3
LABEL_REVISION_NOTE = "2007-09-27,Thierry Sémon(UoB),
                        version2.1 release;"
RECORD_TYPE = FIXED_LENGTH
RECORD_BYTES = 80
FILE_RECORDS = 474
LABEL_RECORDS = 79
^DFMS_HK_TABLE = 80
^CEM_DATA_TABLE = 325
DATA_SET_ID = "RO-X-ROSINA-2-ENG-V1.0"
DATA_SET_NAME = "ROSETTA-ORBITER CHECK ROSINA 2
                 ENGINEERING V1.0"
PRODUCT_ID = CE_20050706_144901086_M0160
PRODUCT_CREATION_TIME = 2006-10-19T14:58:40.953
PRODUCT_TYPE = EDR
PROCESSING_LEVEL_ID = "2"
MISSION_ID = ROSETTA
MISSION_NAME = "INTERNATIONAL ROSETTA MISSION"
TARGET_NAME = "CHECKOUT"
TARGET_TYPE = "N/A"
MISSION_PHASE_NAME = "COMMISSIONING"
INSTRUMENT_HOST_NAME = "ROSETTA-ORBITER"
INSTRUMENT_HOST_ID = RO
INSTRUMENT_NAME = "ROSETTA ORBITER SPECTROMETER FOR
                   ION AND NEUTRAL ANALYSIS"
INSTRUMENT_ID = ROSINA
INSTRUMENT_MODE_ID = M0160
^INSTRUMENT_MODE_DESC = "DFMS_MODE_DESC.TXT"
INSTRUMENT_TYPE = "MASS SPECTROMETER"
DETECTOR_ID = DFMS
DETECTOR_DESC = "DOUBLE FOCUSING MASS SPECTROMETER"
CHANNEL_ID = CE
START_TIME = 2005-07-06T14:48:39.583
STOP_TIME = 2005-07-06T14:49:22.583
SPACECRAFT_CLOCK_START_COUNT = "1/79282098.217"
SPACECRAFT_CLOCK_STOP_COUNT = "1/79282141.217"
PRODUCER_ID = ROSETTA_ROSINA
PRODUCER_FULL_NAME = "KATHRIN ALTWEGG"
PRODUCER_INSTITUTION_NAME = "UNIVERSITY OF BERN"
DATA_QUALITY_ID = "3"
DATA_QUALITY_DESC = "Uncompressed or lossless compression"
SC_SUN_POSITION_VECTOR = "N/A"
SC_TARGET_POSITION_VECTOR = "N/A"
COORDINATE_SYSTEM_ID = "N/A"
COORDINATE_SYSTEM_NAME = "N/A"
SC_TARGET_VELOCITY_VECTOR = "N/A"
SPACECRAFT_ALTITUDE = "N/A"
SUB_SPACECRAFT_LATITUDE = "N/A"
SUB_SPACECRAFT_LONGITUDE = "N/A"
DESCRIPTION = "This file contains results from the
               Double Focusing Mass Spectrometer
               (DFMS) instrument flown aboard the
               ROSETTA spacecraft during its mission
               to comet 67P/Churyumov-Gerasimenko."
NOTE = "
        The EME J2000 reference frame is used for all position and
        velocity vectors. Latitude and Longitude are PLANETOGRAPHIC
```



north latitudes and west longitudes. All values are computed at t = START_TIME. Distances are given in <km>, velocities in <km/s>, and angles in <deg>."

```
OBJECT = DFMS_HK_TABLE
NAME = DFMS_HOUSEKEEPING_TABLE
INTERCHANGE_FORMAT = ASCII
ROWS = 245
COLUMNS = 5
ROW_BYTES = 80
^STRUCTURE = "DFMS_HK.FMT"
END_OBJECT = DFMS_HK_TABLE

OBJECT = CEM_DATA_TABLE
NAME = DFMS_CEM_DATA_TABLE
INTERCHANGE_FORMAT = ASCII
ROWS = 150
COLUMNS = 6
ROW_BYTES = 80
^STRUCTURE = "DFMS_CE_DATA.FMT"
END_OBJECT = CEM_DATA_TABLE
END
```

4.3.4 DFMS FA EDR Data Product Design

```
PDS_VERSION_ID = PDS3
LABEL_REVISION_NOTE = "2007-09-27,Thierry Sémon(UoB),
version2.1 release;"

RECORD_TYPE = FIXED_LENGTH
RECORD_BYTES = 80
FILE_RECORDS = 474
LABEL_RECORDS = 79
^DFMS_HK_TABLE = 80
^FAR_DATA_TABLE = 325
DATA_SET_ID = "RO-X-ROSINA-2-ENG-V1.0"
DATA_SET_NAME = "ROSETTA-ORBITER CHECK ROSINA 2
ENGINEERING V1.0"

PRODUCT_ID = FA_20050209_161014240_M0170
PRODUCT_CREATION_TIME = 2006-10-19T15:05:39.187
PRODUCT_TYPE = EDR
PROCESSING_LEVEL_ID = "2"
MISSION_ID = ROSETTA
MISSION_NAME = "INTERNATIONAL ROSETTA MISSION"
TARGET_NAME = "CHECKOUT"
TARGET_TYPE = "N/A"
MISSION_PHASE_NAME = "COMMISSIONING"
INSTRUMENT_HOST_NAME = "ROSETTA-ORBITER"
INSTRUMENT_HOST_ID = RO
INSTRUMENT_NAME = "ROSETTA ORBITER SPECTROMETER FOR
ION AND NEUTRAL ANALYSIS"

INSTRUMENT_ID = ROSINA
INSTRUMENT_MODE_ID = M0170
^INSTRUMENT_MODE_DESC = "DFMS_MODE_DESC.TXT"
INSTRUMENT_TYPE = "MASS SPECTROMETER"
DETECTOR_ID = DFMS
DETECTOR_DESC = "DOUBLE FOCUSING MASS SPECTROMETER"
CHANNEL_ID = FA
START_TIME = 2005-02-09T16:10:14.367
```



ROSINA - EAICD

Document No. : RO-ROS-MAN-1039
Issue/Rev. No. : 1.82
Date : 21 March 2016
Page : 43

STOP_TIME = 2005-02-09T16:10:56.367
SPACECRAFT_CLOCK_START_COUNT = "1/66586214.240"
SPACECRAFT_CLOCK_STOP_COUNT = "1/66586256.241"
PRODUCER_ID = ROSETTA_ROSINA
PRODUCER_FULL_NAME = "KATHRIN ALTWEGG"
PRODUCER_INSTITUTION_NAME = "UNIVERSITY OF BERN"
DATA_QUALITY_ID = "3"
DATA_QUALITY_DESC = " Uncompressed or lossless compression"
SC_SUN_POSITION_VECTOR = "N/A"
SC_TARGET_POSITION_VECTOR = "N/A"
COORDINATE_SYSTEM_ID = "N/A"
COORDINATE_SYSTEM_NAME = "N/A"
SC_TARGET_VELOCITY_VECTOR = "N/A"
SPACECRAFT_ALTITUDE = "N/A"
SUB_SPACECRAFT_LATITUDE = "N/A"
SUB_SPACECRAFT_LONGITUDE = "N/A"
DESCRIPTION = "This file contains results from the
Double Focusing Mass Spectrometer
(DFMS) instrument flown aboard the
ROSETTA spacecraft during its mission
to comet 67P/Churyumov-Gerasimenko."

NOTE = "
The EME J2000 reference frame is used for all position and
velocity vectors. Latitude and Longitude are PLANETOGRAPHIC
north latitudes and west longitudes. All values are computed
at t = START_TIME. Distances are given in <km>, velocities in
<km/s>, and angles in <deg>."

OBJECT = DFMS_HK_TABLE
NAME = DFMS_HOUSEKEEPING_TABLE
INTERCHANGE_FORMAT = ASCII
ROWS = 245
COLUMNS = 5
ROW_BYTES = 80
^STRUCTURE = "DFMS_HK.FMT"
END_OBJECT = DFMS_HK_TABLE

OBJECT = FAR_DATA_TABLE
NAME = DFMS_FAR_DATA_TABLE
INTERCHANGE_FORMAT = ASCII
ROWS = 150
COLUMNS = 3
ROW_BYTES = 80
^STRUCTURE = "DFMS_FA_DATA.FMT"
END_OBJECT = FAR_DATA_TABLE
END

4.3.5 DFMS MC EDR Data Product Design

PDS_VERSION_ID = PDS3
LABEL_REVISION_NOTE = "2007-09-27,Thierry Sémon(UoB),
version2.1 release;"
RECORD_TYPE = FIXED_LENGTH
RECORD_BYTES = 80
FILE_RECORDS = 836
LABEL_RECORDS = 79
^DFMS_HK_TABLE = 80
^MCP_DATA_TABLE = 325
DATA_SET_ID = "RO-X-ROSINA-2-ENG-V1.0"



ROSINA - EAICD

Document No. : RO-ROS-MAN-1039
Issue/Rev. No. : 1.82
Date : 21 March 2016
Page : 44

```
DATA_SET_NAME           = "ROSETTA-ORBITER CHECK ROSINA 2
                          ENGINEERING V1.0"
PRODUCT_ID              = MC_20050706_102458654_M0005
PRODUCT_CREATION_TIME   = 2006-10-19T14:58:17.500
PRODUCT_TYPE            = EDR
PROCESSING_LEVEL_ID     = "2"
MISSION_ID              = ROSETTA
MISSION_NAME            = "INTERNATIONAL ROSETTA MISSION"
TARGET_NAME             = "CHECKOUT"
TARGET_TYPE            = "N/A"
MISSION_PHASE_NAME      = "COMMISSIONING"
INSTRUMENT_HOST_NAME    = "ROSETTA-ORBITER"
INSTRUMENT_HOST_ID      = RO
INSTRUMENT_NAME         = "ROSETTA ORBITER SPECTROMETER FOR
                          ION AND NEUTRAL ANALYSIS"
INSTRUMENT_ID           = ROSINA
INSTRUMENT_MODE_ID      = M0005
^INSTRUMENT_MODE_DESC   = "DFMS_MODE_DESC.TXT"
INSTRUMENT_TYPE         = "MASS SPECTROMETER"
DETECTOR_ID            = DFMS
DETECTOR_DESC           = "DOUBLE FOCUSING MASS SPECTROMETER"
CHANNEL_ID             = MC
START_TIME              = 2005-07-06T10:25:20.248
STOP_TIME               = 2005-07-06T10:25:20.448
SPACECRAFT_CLOCK_START_COUNT = "1/79266298.654"
SPACECRAFT_CLOCK_STOP_COUNT = "1/79266299.130"
PRODUCER_ID            = ROSETTA_ROSINA
PRODUCER_FULL_NAME      = "KATHRIN ALTWEGG"
PRODUCER_INSTITUTION_NAME = "UNIVERSITY OF BERN"
DATA_QUALITY_ID        = "3"
DATA_QUALITY_DESC       = "Uncompressed or lossless compression"
SC_SUN_POSITION_VECTOR  = "N/A"
SC_TARGET_POSITION_VECTOR = "N/A"
COORDINATE_SYSTEM_ID    = "N/A"
COORDINATE_SYSTEM_NAME  = "N/A"
SC_TARGET_VELOCITY_VECTOR = "N/A"
SPACECRAFT_ALTITUDE     = "N/A"
SUB_SPACECRAFT_LATITUDE = "N/A"
SUB_SPACECRAFT_LONGITUDE = "N/A"
DESCRIPTION             = "This file contains results from the
                          Double Focusing Mass Spectrometer
                          (DFMS) instrument flown aboard the
                          ROSETTA spacecraft during its mission
                          to comet 67P/Churyumov-Gerasimenko."
NOTE                    = "
                          The EME J2000 reference frame is used for all position and
                          velocity vectors. Latitude and Longitude are PLANETOGRAPHIC
                          north latitudes and west longitudes. All values are computed
                          at t = START_TIME. Distances are given in <km>, velocities in
                          <km/s>, and angles in <deg>."
OBJECT                  = DFMS_HK_TABLE
NAME                    = DFMS_HOUSEKEEPING_TABLE
INTERCHANGE_FORMAT      = ASCII
ROWS                    = 245
COLUMNS                = 5
ROW_BYTES               = 80
^STRUCTURE              = "DFMS_HK.FMT"
END_OBJECT              = DFMS_HK_TABLE
```



```
OBJECT = MCP_DATA_TABLE
NAME = DFMS_MCP_DATA_TABLE
INTERCHANGE_FORMAT = ASCII
ROWS = 512
COLUMNS = 4
ROW_BYTES = 80
^STRUCTURE = "DFMS_MC_DATA.FMT"
END_OBJECT = MCP_DATA_TABLE
END
```

4.3.6 RTOF OS EDR Data Product Design

The same design applies to RTOF SS data

```
PDS_VERSION_ID = PDS3
LABEL_REVISION_NOTE = "2009-09-27,Thierry Sémon(UoB),
version2.1 release;"

RECORD_TYPE = FIXED_LENGTH
RECORD_BYTES = 80
FILE_RECORDS = 131470
LABEL_RECORDS = 79
^RTOF_HK_TABLE = 80
^RTOF_DATA_TABLE = 372
DATA_SET_ID = "RO-X-ROSINA-2-ENG-V1.0"
DATA_SET_NAME = "ROSETTA-ORBITER CHECK ROSINA 2
ENGINEERING V1.0"

PRODUCT_ID = OS_20050323_183003527_M9999
PRODUCT_CREATION_TIME = 2006-10-19T14:35:02.984
PRODUCT_TYPE = EDR
PROCESSING_LEVEL_ID = "2"
MISSION_ID = ROSETTA
MISSION_NAME = "INTERNATIONAL ROSETTA MISSION"
TARGET_NAME = "CHECKOUT"
TARGET_TYPE = "N/A"
MISSION_PHASE_NAME = "COMMISSIONING"
INSTRUMENT_HOST_NAME = "ROSETTA-ORBITER"
INSTRUMENT_HOST_ID = RO
INSTRUMENT_NAME = "ROSETTA ORBITER SPECTROMETER FOR
ION AND NEUTRAL ANALYSIS"

INSTRUMENT_ID = ROSINA
INSTRUMENT_MODE_ID = M9999
^INSTRUMENT_MODE_DESC = "RTOF_MODE_DESC.TXT"
INSTRUMENT_TYPE = "MASS SPECTROMETER"
DETECTOR_ID = RTOF
DETECTOR_DESC = "REFLECTRON TIME OF FLIGHT"
CHANNEL_ID = OS
START_TIME = 2005-03-23T18:30:03.804
STOP_TIME = 2005-03-23T18:33:23.804
SPACECRAFT_CLOCK_START_COUNT = "1/70223403.527"
SPACECRAFT_CLOCK_STOP_COUNT = "1/70223603.527"
PRODUCER_ID = ROSETTA_ROSINA
PRODUCER_FULL_NAME = "KATHRIN ALTWEGG"
PRODUCER_INSTITUTION_NAME = "UNIVERSITY OF BERN"
DATA_QUALITY_ID = "3"
DATA_QUALITY_DESC = "Uncompressed or lossless compression"
SC_SUN_POSITION_VECTOR = "N/A"
SC_TARGET_POSITION_VECTOR = "N/A"
COORDINATE_SYSTEM_ID = "N/A"
```



```

COORDINATE_SYSTEM_NAME      =      "N/A"
SC_TARGET_VELOCITY_VECTOR   =      "N/A"
SPACECRAFT_ALTITUDE         =      "N/A"
SUB_SPACECRAFT_LATITUDE     =      "N/A"
SUB_SPACECRAFT_LONGITUDE    =      "N/A"
DESCRIPTION                  =      "This file contains results from the
                                   Reflection Time Of Flight Spectrometer
                                   (RTOF) instrument flown aboard the
                                   ROSETTA spacecraft during its mission
                                   to comet 67P/Churyumov-Gerasimenko."

```

```

NOTE                          =      "
The EME J2000 reference frame is used for all position and
velocity vectors. Latitude and Longitude are PLANETOGRAPHIC
north latitudes and west longitudes. All values are computed
at t = START_TIME. Distances are given in <km>, velocities in
<km/s>, and angles in <deg>."

```

```

OBJECT                         =      RTOF_HK_TABLE
NAME                           =      RTOF_HOUSEKEEPING_TABLE
INTERCHANGE_FORMAT             =      ASCII
ROWS                           =      292
COLUMNS                       =      5
ROW_BYTES                     =      80
^STRUCTURE                     =      "RTOF_HK.FMT"
END_OBJECT                     =      RTOF_HK_TABLE

```

```

OBJECT                         =      RTOF_DATA_TABLE
NAME                           =      RTOF_DATA_TABLE
INTERCHANGE_FORMAT             =      ASCII
ROWS                           =      131099
COLUMNS                       =      4
ROW_BYTES                     =      80
^STRUCTURE                     =      "RTOF_DATA.FMT"
END_OBJECT                     =      RTOF_DATA_TABLE
END

```

4.4 A label in a close view – CODMAC L2

4.4.1 File Characteristics Data Elements

```

RECORD_TYPE                    =      FIXED_LENGTH
FILE_NAME                      =      OS_20050323_193003715_M9999.TAB

```

The fixed length record type is used for the ROSINA data.

4.4.2 Data Object Pointers Identification Data Elements

```

^RTOF_HK_TABLE                 =      80
^RTOF_DATA_TABLE               =      372

```

Since attached label are used, the pointers refer to a position in the same file.



4.4.3 Identification Data Elements

```
DATA_SET_ID = "RO-X-ROSINA-2-ENG-V1.0"  
DATA_SET_NAME = "ROSETTA-ORBITER CHECK ROSINA 2  
ENGINEERING V1.0"  
PRODUCT_ID = OS_20050323_183003527_M9999  
PRODUCT_CREATION_TIME = 2006-10-19T14:35:02.984  
PRODUCT_TYPE = EDR  
PROCESSING_LEVEL_ID = "2"  
MISSION_ID = ROSETTA  
MISSION_NAME = "INTERNATIONAL ROSETTA MISSION"  
TARGET_NAME = "CHECKOUT"  
TARGET_TYPE = "N/A"  
MISSION_PHASE_NAME = "COMMISSIONING"  
INSTRUMENT_HOST_NAME = "ROSETTA-ORBITER"  
INSTRUMENT_HOST_ID = RO  
INSTRUMENT_NAME = "ROSETTA ORBITER SPECTROMETER FOR  
ION AND NEUTRAL ANALYSIS"  
  
INSTRUMENT_ID = ROSINA  
INSTRUMENT_MODE_ID = M9999  
^INSTRUMENT_MODE_DESC = "RTOF_MODE_DESC.TXT"  
INSTRUMENT_TYPE = "MASS SPECTROMETER"  
DETECTOR_ID = RTOF  
DETECTOR_DESC = "REFLECTRON TIME OF FLIGHT"  
CHANNEL_ID = OS  
START_TIME = 2005-03-23T18:30:03.804  
STOP_TIME = 2005-03-23T18:33:23.804  
SPACECRAFT_CLOCK_START_COUNT = "1/70223403.527"  
SPACECRAFT_CLOCK_STOP_COUNT = "1/70223603.527"  
PRODUCER_ID = ROSETTA_ROSINA  
PRODUCER_FULL_NAME = "KATHRIN ALTWEGG"  
PRODUCER_INSTITUTION_NAME = "UNIVERSITY OF BERN"  
DATA_QUALITY_ID = "3"  
DATA_QUALITY_DESC = "Uncompressed or lossless compression"
```

The ROSINA team has defined the DATA_QUALITY_ID keyword values below:

```
0 means "Detector readout anomaly"  
1 means "Data related to HK anomaly"  
2 means "Lossy compression"  
3 means "Uncompressed or lossless compression"
```

4.4.4 Descriptive Data Elements

```
INSTRUMENT_ID = ROSINA  
INSTRUMENT_MODE_ID = M9999  
^INSTRUMENT_MODE_DESC = "RTOF_MODE_DESC.TXT"  
INSTRUMENT_TYPE = "MASS SPECTROMETER"  
SC_SUN_POSITION_VECTOR = (-1.1245E+08 <KM>, 5.3050E+08 <KM>,  
2.9426E+08 <KM>)  
SC_TARGET_POSITION_VECTOR = (-1.0083E+06 <KM>,-2.5010E+06 <KM>,  
-6.4243E+05 <KM>)  
SC_TARGET_VELOCITY_VECTOR = ( 2.8987E-01 <KM/S>, 6.9975E-01 <KM/S>,  
1.7124E-01 <KM/S>)  
SPACECRAFT_ALTITUDE = 2.7721E+06 <KM>  
SUB_SPACECRAFT_LATITUDE = 3.9405E+01 <DEG>  
SUB_SPACECRAFT_LONGITUDE = 1.3405E+02 <DEG>
```



```
SPICE_FILE_NAME      =      {"NAIF0011.TLS",  
                             "DE405.BSP",  
                             "ROS_V24.TF",  
                             "ROS_CHURYUMOV_V01.TF",  
                             "ROS_150414_STEP.TSC",  
                             "CATT_DV_102_01_____00169.BC",  
                             "CORB_DV_102_01_____00169.BSP",  
                             "RORB_DV_102_01_____00169.BSP",  
                             "RATT_DV_102_01_01_____00169.BC"}  
DESCRIPTION          =      "This file contains results from the  
                             Reflectron Time Of Flight Spectrometer  
                             (RTOF) instrument flown aboard the  
                             ROSETTA spacecraft during its mission  
                             to comet 67P/Churyumov-Gerasimenko."  
NOTE                 =      "  
The values of the keywords SC_SUN_POSITION_VECTOR, SC_TARGET_POSITION_VECTOR,  
SC_TARGET_VELOCITY_VECTOR are related to the equatorial J2000 inertial frame.  
The values of SUB_SPACECRAFT_LATITUDE and SUB_SPACECRAFT_LONGITUDE refer to  
the Cheops reference frame.  
The SPACECRAFT_ALTITUDE gives the distance to the spacecraft from the target  
center of mass. All values are computed for the time t=START_TIME.  
Distances are given in <km>, velocities in <km/s>, and angles in <deg>."
```

4.4.5 Data Object Definitions

4.4.5.1 Table objects for COPS

```
OBJECT               =      COPS_HK_TABLE  
  NAME               =      COPS_HOUSEKEEPING_TABLE  
  INTERCHANGE_FORMAT =      ASCII  
  ROWS               =      338  
  COLUMNS           =      5  
  ROW_BYTES         =      80  
  ^STRUCTURE        =      "COPS_HK.FMT"  
END_OBJECT          =      COPS_HK_TABLE  
  
OBJECT               =      COPS_SC_DATA_TABLE  
  NAME               =      COPS_DATA_TABLE  
  INTERCHANGE_FORMAT =      ASCII  
  ROWS               =      150  
  COLUMNS           =      3  
  ROW_BYTES         =      80  
  ^STRUCTURE        =      "COPS_DATA.FMT"  
END_OBJECT          =      COPS_SC_DATA_TABLE
```



ROSINA - EAICD

Document No. : RO-ROS-MAN-1039
Issue/Rev. No. : 1.82
Date : 21 March 2016
Page : 49

---Contents of the file COPS_HK.FMT:-----

```
OBJECT = COLUMN
NAME = RTOF_HOUSEKEEPING_NAME
DESCRIPTION = "Name of the provided housekeeping
value. Example: ROSINA_RTOF_SCI_COUNT"

UNIT = "S"
DATA_TYPE = CHARACTER
START_BYTE = 2
BYTES = 32
END_OBJECT = COLUMN
OBJECT = COLUMN
NAME = RTOF_HOUSEKEEPING_STATUS
DESCRIPTION = "Status, interpreted value, or discrete
value of the housekeeping. Examples:
ON; OFF; GAS; HIGH; 10kHz. Field is
empty in case of non status
housekeeping."

DATA_TYPE = CHARACTER
START_BYTE = 37
BYTES = 5
END_OBJECT = COLUMN
OBJECT = COLUMN
NAME = RTOF_HOUSEKEEPING_VALUE
DESCRIPTION = "Exact value of the housekeeping.
Examples: 67; 634; +2.0430E-004; OX62.
Field is empty in case of status
housekeeping."

DATA_TYPE = CHARACTER
START_BYTE = 45
BYTES = 15
END_OBJECT = COLUMN
OBJECT = COLUMN
NAME = RTOF_HOUSEKEEPING_UNIT
DESCRIPTION = "Unit of the exact housekeeping value.
Examples: V; mA; DegC; ns.
Field is empty in case of status
housekeeping or unitless values."

DATA_TYPE = CHARACTER
START_BYTE = 63
BYTES = 5
END_OBJECT = COLUMN
OBJECT = COLUMN
NAME = "SPARE"
DESCRIPTION = "Blank padding to fixed record length"
DATA_TYPE = "CHARACTER"
START_BYTE = 69
BYTES = 10
END_OBJECT = COLUMN
--- EOF -----
```

--- Contents of the file COPS_DATA.FMT: -----

```
OBJECT = COLUMN
NAME = TIMESTAMP
DESCRIPTION = "DPU UTC Timestamp of the readout"
UNIT = "S"
DATA_TYPE = ASCII_INTEGER
START_BYTE = 1
BYTES = 10
END_OBJECT = COLUMN
OBJECT = COLUMN
```



```
NAME = PRESSURE
DESCRIPTION = "Pressure from either NG or RG
              measured in millibar."
UNIT = "MILLIBAR"
DATA_TYPE = ASCII_REAL
START_BYTE = 12
BYTES = 15
END_OBJECT = COLUMN
OBJECT = COLUMN
NAME = "SPARE"
DESCRIPTION = "Blank padding to fixed record length"
DATA_TYPE = "CHARACTER"
START_BYTE = 28
BYTES = 51
END_OBJECT = COLUMN
--- EOF -----
```

The DPU Timestamp values contained in the COPS_DATA.FMT label file are calculated values. The first value correspond exactly to the START_TIME keyword value of the COPS SC EDR Data Product Design, the next Timestamps are just spaced by 2 seconds.

4.4.5.2 Table objects for DFMS

```
OBJECT = DFMS_HK_TABLE
NAME = DFMS_HOUSEKEEPING_TABLE
INTERCHANGE_FORMAT = ASCII
ROWS = 245
COLUMNS = 5
ROW_BYTES = 80
^STRUCTURE = "DFMS_HK.FMT"
END_OBJECT = DFMS_HK_TABLE
```

```
OBJECT = MCP_DATA_TABLE
NAME = DFMS_MCP_DATA_TABLE
INTERCHANGE_FORMAT = ASCII
ROWS = 512
COLUMNS = 4
ROW_BYTES = 80
^STRUCTURE = "DFMS_MC_DATA.FMT"
END_OBJECT = MCP_DATA_TABLE
END
```

```
OBJECT = CEM_DATA_TABLE
NAME = DFMS_CEM_DATA_TABLE
INTERCHANGE_FORMAT = ASCII
ROWS = 150
COLUMNS = 6
ROW_BYTES = 80
^STRUCTURE = "DFMS_CE_DATA.FMT"
END_OBJECT = CEM_DATA_TABLE
```

```
OBJECT = FAR_DATA_TABLE
NAME = DFMS_FAR_DATA_TABLE
INTERCHANGE_FORMAT = ASCII
ROWS = 150
COLUMNS = 3
ROW_BYTES = 80
```



ROSINA - EAICD

Document No. : RO-ROS-MAN-1039
Issue/Rev. No. : 1.82
Date : 21 March 2016
Page : 51

```
^STRUCTURE = "DFMS_FA_DATA.FMT"  
END_OBJECT = FAR_DATA_TABLE  
END
```

```
--- Contents of the file DFMS_HK.FMT -----  
OBJECT = COLUMN  
  NAME = DFMS_HOUSEKEEPING_NAME  
  DESCRIPTION = "Name of the provided housekeeping  
  value. Example: ROSINA_DFMS_CEM_FRONT"  
  DATA_TYPE = CHARACTER  
  START_BYTE = 2  
  BYTES = 32  
END_OBJECT = COLUMN  
OBJECT = COLUMN  
  NAME = DFMS_HOUSEKEEPING_STATUS  
  DESCRIPTION = "Status, interpreted value, or discrete  
  value of the housekeeping. Examples:  
  ON; OFF; LOW; HIGH; 2uA. Field is  
  empty in case of non status  
  housekeeping."  
  DATA_TYPE = CHARACTER  
  START_BYTE = 37  
  BYTES = 5  
END_OBJECT = COLUMN  
OBJECT = COLUMN  
  NAME = DFMS_HOUSEKEEPING_VALUE  
  DESCRIPTION = "Exact value of the housekeeping.  
  Examples: -0.39; 773; 1.4498E+001;  
  OX1E. Field is empty in case of status  
  housekeeping."  
  DATA_TYPE = CHARACTER  
  START_BYTE = 45  
  BYTES = 15  
END_OBJECT = COLUMN  
OBJECT = COLUMN  
  NAME = DFMS_HOUSEKEEPING_UNIT  
  DESCRIPTION = "Unit of the exact housekeeping value.  
  Examples: V; mbar; nA; uA.  
  Field is empty in case of status  
  housekeeping or unitless values."  
  DATA_TYPE = CHARACTER  
  START_BYTE = 63  
  BYTES = 5  
END_OBJECT = COLUMN  
OBJECT = COLUMN  
  NAME = "SPARE"  
  DESCRIPTION = "Blank padding to fixed record length"  
  DATA_TYPE = "CHARACTER"  
  START_BYTE = 69  
  BYTES = 10  
END_OBJECT = COLUMN  
--- EOF -----
```

```
--- Contents of file DFMS_MC_DATA.FMT -----  
OBJECT = COLUMN  
  NAME = PIXELNUMBER  
  DESCRIPTION = "LEDA Pixel Number. The values are in  
  the range from 1 to 512 and
```



ROSINA - EAICD

Document No. : RO-ROS-MAN-1039
 Issue/Rev. No. : 1.82
 Date : 21 March 2016
 Page : 52

```

                                ascending."
UNIT                           = "PIXEL_NUMBER"
DATA_TYPE                       = ASCII_INTEGER
START_BYTE                      = 1
BYTES                           = 3
END_OBJECT                      = COLUMN
OBJECT                          = COLUMN
NAME                            = LEDA_A
DESCRIPTION                     = "Accumulated counts of the LEDA Row A"
UNIT                            = "COUNTS"
DATA_TYPE                       = ASCII_INTEGER
START_BYTE                      = 5
BYTES                           = 12
END_OBJECT                      = COLUMN
OBJECT                          = COLUMN
NAME                            = LEDA_B
UNIT                            = "COUNTS"
DESCRIPTION                     = "Accumulated counts of the LEDA Row B"
DATA_TYPE                       = ASCII_INTEGER
START_BYTE                      = 18
BYTES                           = 12
END_OBJECT                      = COLUMN
OBJECT                          = COLUMN
NAME                            = "SPARE"
DESCRIPTION                     = "Blank padding to fixed record length"
DATA_TYPE                       = "CHARACTER"
START_BYTE                      = 31
BYTES                           = 48
END_OBJECT                      = COLUMN
--- EOF -----

```

The first pixel value in counts of LEDA Row A and LEDA Row B is always 0.

```

--- Contents of file DFMS_CE_DATA.FMT-----
OBJECT                          = COLUMN
NAME                            = STEP
DESCRIPTION                     = "CEM Step Number. The values are in the
                                range from 1 to 150 and ascending."
UNIT                            = "STEP_NUMBER"
DATA_TYPE                       = ASCII_INTEGER
START_BYTE                      = 1
BYTES                           = 3
END_OBJECT                      = COLUMN
OBJECT                          = COLUMN
NAME                            = COUNTS
DESCRIPTION                     = "Digital counts of the channeltron."
UNIT                            = "COUNTS"
DATA_TYPE                       = ASCII_INTEGER
START_BYTE                      = 5
BYTES                           = 12
END_OBJECT                      = COLUMN
OBJECT                          = COLUMN
NAME                            = GAIN
DESCRIPTION                     = "Gain which was used. Default is 16."
UNIT                            = "GAIN_NUMBER"
DATA_TYPE                       = ASCII_INTEGER
START_BYTE                      = 18
BYTES                           = 12
END_OBJECT                      = COLUMN

```



ROSINA - EAICD

Document No. : RO-ROS-MAN-1039
Issue/Rev. No. : 1.82
Date : 21 March 2016
Page : 53

```
OBJECT = COLUMN
NAME = ANALOG_HG
DESCRIPTION = "Analog signal with high-gain."
UNIT = "COUNTS"
DATA_TYPE = ASCII_REAL
START_BYTE = 31
BYTES = 15
END_OBJECT = COLUMN
OBJECT = COLUMN
NAME = ANALOG_LG
UNIT = "COUNTS"
DESCRIPTION = "Analog signal with low-gain."
DATA_TYPE = ASCII_REAL
START_BYTE = 47
BYTES = 15
END_OBJECT = COLUMN
OBJECT = COLUMN
NAME = "SPARE"
DESCRIPTION = "Blank padding to fixed record length"
DATA_TYPE = "CHARACTER"
START_BYTE = 63
BYTES = 16
END_OBJECT = COLUMN
--- EOF -----
```

```
--- Contents of file DFMS_FA_DATA.FMT-----
OBJECT = COLUMN
NAME = STEP
DESCRIPTION = "FAR Step Number. The values are in the
range from 1 to 150 and ascending."
UNIT = "STEP_NUMBER"
DATA_TYPE = ASCII_INTEGER
START_BYTE = 1
BYTES = 3
END_OBJECT = COLUMN
OBJECT = COLUMN
NAME = VOLTAGE
DESCRIPTION = "Faraday Cup Voltage, Unit: mV"
UNIT = "mV"
DATA_TYPE = ASCII_REAL
START_BYTE = 5
BYTES = 12
END_OBJECT = COLUMN
OBJECT = COLUMN
NAME = "SPARE"
DESCRIPTION = "Blank padding to fixed record length"
DATA_TYPE = "CHARACTER"
START_BYTE = 18
BYTES = 59
END_OBJECT = COLUMN
--- EOF -----
```



4.4.5.3 Table object for RTOF

```
OBJECT = RTOF_HK_TABLE
NAME = RTOF_HOUSEKEEPING_TABLE
INTERCHANGE_FORMAT = ASCII
ROWS = 292
COLUMNS = 5
ROW_BYTES = 80
^STRUCTURE = "RTOF_HK.FMT"
END_OBJECT = RTOF_HK_TABLE
```

```
OBJECT = RTOF_DATA_TABLE
NAME = RTOF_DATA_TABLE
INTERCHANGE_FORMAT = ASCII
ROWS = 131099
COLUMNS = 4
ROW_BYTES = 80
^STRUCTURE = "RTOF_DATA.FMT"
END_OBJECT = RTOF_DATA_TABLE
```

--- Contents of file RTOF_HK.FMT-----

```
OBJECT = COLUMN
NAME = RTOF_HOUSEKEEPING_NAME
DESCRIPTION = "Name of the provided housekeeping
value. Example: ROSINA_RTOF_SCI_COUNT"
DATA_TYPE = CHARACTER
START_BYTE = 2
BYTES = 32
END_OBJECT = COLUMN
OBJECT = COLUMN
NAME = RTOF_HOUSEKEEPING_STATUS
DESCRIPTION = "Status, interpreted value, or discrete
value of the housekeeping. Examples:
ON; OFF; GAS; HIGH; 10kHz. Field is
empty in case of non status
housekeeping."
DATA_TYPE = CHARACTER
START_BYTE = 37
BYTES = 5
END_OBJECT = COLUMN
OBJECT = COLUMN
NAME = RTOF_HOUSEKEEPING_VALUE
DESCRIPTION = "Exact value of the housekeeping.
Examples: 67; 634; +2.0430E-004; 0X62.
Field is empty in case of status
housekeeping."
DATA_TYPE = CHARACTER
START_BYTE = 45
BYTES = 15
END_OBJECT = COLUMN
OBJECT = COLUMN
NAME = RTOF_HOUSEKEEPING_UNIT
DESCRIPTION = "Unit of the exact housekeeping value.
Examples: V; mA; DegC; ns.
Field is empty in case of status
```



```
housekeeping or unitless values."  
DATA_TYPE = CHARACTER  
START_BYTE = 63  
BYTES = 5  
END_OBJECT = COLUMN  
OBJECT = COLUMN  
NAME = "SPARE"  
DESCRIPTION = "Blank padding to fixed record length"  
DATA_TYPE = "CHARACTER"  
START_BYTE = 69  
BYTES = 10  
END_OBJECT = COLUMN -  
-- EOF -----
```

```
--- Contents of file RTOF_DATA.FMT-----  
OBJECT = COLUMN  
NAME = COUNT  
DESCRIPTION = "Channelnumber. The values are in the  
range from 1 to 131099 and ascending."  
UNIT = "CHANNEL_NUMBER"  
DATA_TYPE = ASCII_INTEGER  
START_BYTE = 1  
BYTES = 6  
END_OBJECT = COLUMN  
OBJECT = COLUMN  
NAME = HISTOGRAM  
DESCRIPTION = "Histogram data of RTOF ETS. Field  
contains 0 for ETSL"  
UNIT = "EVENT_NUMBER"  
DATA_TYPE = ASCII_INTEGER  
START_BYTE = 8  
BYTES = 17  
END_OBJECT = COLUMN  
OBJECT = COLUMN  
NAME = EVENT  
DESCRIPTION = "RTOF Event data of either ETS or ETSL"  
UNIT = "EVENT_NUMBER"  
DATA_TYPE = ASCII_INTEGER  
START_BYTE = 26  
BYTES = 17  
END_OBJECT = COLUMN  
OBJECT = COLUMN  
NAME = "SPARE"  
DESCRIPTION = "Blank padding to fixed record length"  
DATA_TYPE = "CHARACTER"  
START_BYTE = 44  
BYTES = 35  
END_OBJECT = COLUMN -  
- EOF -----
```

4.4.6 Parameters Index File Definition

The index files are automatically generated by the PVV program.



ROSINA - EAICD

Document No. : RO-ROS-MAN-1039
Issue/Rev. No. : 1.82
Date : 21 March 2016
Page : 56

4.4.7 *Mission Specific Keywords – CODMAC L2*

No left hand ROSINA specific keywords were used for the processing level 2.



4.5 Data Product Design and Sample Labels – CODMAC L3

Reduced data products and model based data products are TBD. For other data products, several "designs" have been defined and are listed together with sample labels (attached data not included).

4.5.1 COPS NG RDR Data Product Design

This design applies for NG, RG and BG files.

```
PDS_VERSION_ID = PDS3
LABEL_REVISION_NOTE = "2007-09-27,Thierry Semon(UoB),
                        version2.1 release;"
RECORD_TYPE = FIXED_LENGTH
RECORD_BYTES = 80
FILE_RECORDS = 154
LABEL_RECORDS = 85
^COPS_HK_TABLE = 86
DATA_SET_ID = "RO-C-ROSINA-3-PRL-V1.0"
DATA_SET_NAME = "ROSETTA-ORBITER 67P ROSINA 3
                PRL V1.0"
PRODUCT_ID = NG_20140329_162750_3_M0342
PRODUCT_CREATION_TIME = 2015-06-01T15:18:43.708
PRODUCT_TYPE = RDR
PROCESSING_LEVEL_ID = "3"
MISSION_ID = ROSETTA
MISSION_NAME = "INTERNATIONAL ROSETTA MISSION"
TARGET_NAME = "67P/CHURYUMOV-GERASIMENKO 1 (1969 R1)"
TARGET_TYPE = "COMET"
MISSION_PHASE_NAME = "PRELANDING"
INSTRUMENT_HOST_NAME = "ROSETTA-ORBITER"
INSTRUMENT_HOST_ID = RO
INSTRUMENT_NAME = "ROSETTA ORBITER SPECTROMETER FOR
                  ION AND NEUTRAL ANALYSIS"
INSTRUMENT_ID = ROSINA
INSTRUMENT_MODE_ID = M0342
^INSTRUMENT_MODE_DESC = "COPS_MODE_DESC.ASC"
INSTRUMENT_TYPE = "MASS SPECTROMETER"
DETECTOR_ID = COPS
DETECTOR_DESC = "COMET PRESSURE SENSOR"
CHANNEL_ID = NG
START_TIME = 2014-03-29T16:28:54.480
STOP_TIME = 2014-03-29T16:29:54.480
SPACECRAFT_CLOCK_START_COUNT = "1/354731270.4680"
SPACECRAFT_CLOCK_STOP_COUNT = "1/354731330.4680"
PRODUCER_ID = ROSETTA_ROSINA
PRODUCER_FULL_NAME = "KATHRIN ALTWEGG"
PRODUCER_INSTITUTION_NAME = "UNIVERSITY OF BERN"
DATA_QUALITY_ID = "3"
DATA_QUALITY_DESC = "
0 means 'Detector readout anomaly'
1 means 'Data related to HK anomaly'
2 means 'Lossy compression'
3 means 'Uncompressed or lossless compression'"
SC_SUN_POSITION_VECTOR = (-9.3937E+07 <KM>, 5.4842E+08 <KM>,
                          3.0217E+08 <KM>)
SC_TARGET_POSITION_VECTOR = (-1.6464E+06 <KM>,-4.0554E+06 <KM>,
```



SC_TARGET_VELOCITY_VECTOR = (-1.0257E+06 <KM>
(2.8653E-01 <KM/S>, 7.0511E-01 <KM/S>,
1.7537E-01 <KM/S>)
SPACECRAFT_ALTITUDE = 4.4954E+06 <KM>
SUB_SPACECRAFT_LATITUDE = 3.9193E+01 <DEG>
SUB_SPACECRAFT_LONGITUDE = 3.3782E+02 <DEG>
SPICE_FILE_NAME = {"NAIF0011.TLS",
"DE405.BSP",
"ROS_V24.TF",
"ROS_CHURYUMOV_V01.TF",
"ROS_150414_STEP.TSC",
"CATT_DV_102_01_00169.BC",
"CORB_DV_102_01_00169.BSP",
"RORB_DV_102_01_00169.BSP",
"RATT_DV_102_01_01_00169.BC"}
DESCRIPTION = "This file contains results from the
Comet Pressure Sensor(COPS)
instrument flown aboard the ROSETTA
spacecraft during its mission to comet
67P/Churyumov-Gerasimenko."
NOTE = "
The values of the keywords SC_SUN_POSITION_VECTOR, SC_TARGET_POSITION_VECTOR,
SC_TARGET_VELOCITY_VECTOR are related to the equatorial J2000 inertial frame.
The values of SUB_SPACECRAFT_LATITUDE and SUB_SPACECRAFT_LONGITUDE refer to
the Cheops reference frame.
The SPACECRAFT_ALTITUDE gives the distance to the spacecraft from the target
center of mass. All values are computed for the time t=START_TIME.
Distances are given in <km>, velocities in <km/s>, and angles in <deg>."
OBJECT = COPS_HK_TABLE
NAME = COPS_HOUSEKEEPING_TABLE
INTERCHANGE_FORMAT = ASCII
ROWS = 69
COLUMNS = 5
ROW_BYTES = 80
^STRUCTURE = "COPS_HK.FMT"
END_OBJECT = COPS_HK_TABLE
END

4.5.2 COPS SN RDR Data Product Design

The particularity of the COPS science structure is the COPS HK table composed by the 5 last standard COPS HK blocks followed by the last extended COPS HK block received by the DPU.

PDS_VERSION_ID = PDS3
LABEL_REVISION_NOTE = "2007-09-27,Thierry Semon(UoB),
version2.1 release;"
RECORD_TYPE = FIXED_LENGTH
RECORD_BYTES = 80
FILE_RECORDS = 568
LABEL_RECORDS = 95
^COPS_HK_TABLE = 96
^COPS_SC_DATA_TABLE = 419
DATA_SET_ID = "RO-C-ROSINA-3-PRL-V1.0"
DATA_SET_NAME = "ROSETTA-ORBITER 67P ROSINA 3
PRL V1.0"
PRODUCT_ID = SN_20140618_225852_3_M0332
PRODUCT_CREATION_TIME = 2015-05-20T15:58:35.706
PRODUCT_TYPE = RDR



ROSINA - EAICD

Document No. : RO-ROS-MAN-1039
Issue/Rev. No. : 1.82
Date : 21 March 2016
Page : 59

```
PROCESSING_LEVEL_ID = "3"
MISSION_ID = ROSETTA
MISSION_NAME = "INTERNATIONAL ROSETTA MISSION"
TARGET_NAME = "67P/CHURYUMOV-GERASIMENKO 1 (1969 R1)"
TARGET_TYPE = "COMET"
MISSION_PHASE_NAME = "PRELANDING"
INSTRUMENT_HOST_NAME = "ROSETTA-ORBITER"
INSTRUMENT_HOST_ID = RO
INSTRUMENT_NAME = "ROSETTA ORBITER SPECTROMETER FOR
ION AND NEUTRAL ANALYSIS"

INSTRUMENT_ID = ROSINA
INSTRUMENT_MODE_ID = M0332
^INSTRUMENT_MODE_DESC = "COPS_MODE_DESC.ASC"
INSTRUMENT_TYPE = "MASS SPECTROMETER"
DETECTOR_ID = COPS
DETECTOR_DESC = "COMET PRESSURE SENSOR"
CHANNEL_ID = SN
START_TIME = 2014-06-18T22:59:59.702
STOP_TIME = 2014-06-18T23:04:59.702
SPACECRAFT_CLOCK_START_COUNT = "1/361753132.55120"
SPACECRAFT_CLOCK_STOP_COUNT = "1/361753432.55120"
PRODUCER_ID = ROSETTA_ROSINA
PRODUCER_FULL_NAME = "KATHRIN ALTWEGG"
PRODUCER_INSTITUTION_NAME = "UNIVERSITY OF BERN"
DATA_QUALITY_ID = "3"
DATA_QUALITY_DESC = "
0 means 'Detector readout anomaly'
1 means 'Data related to HK anomaly'
2 means 'Lossy compression'
3 means 'Uncompressed or lossless compression'"
SC_SUN_POSITION_VECTOR = (-1.5193E+08 <KM>, 4.8541E+08 <KM>,
2.7399E+08 <KM>)
SC_TARGET_POSITION_VECTOR = (-4.5545E+04 <KM>, -1.5103E+05 <KM>,
-5.1275E+04 <KM>)
SC_TARGET_VELOCITY_VECTOR = ( 3.3363E-02 <KM/S>, 9.2933E-02 <KM/S>,
2.8413E-02 <KM/S>)

SPACECRAFT_ALTITUDE = 1.6588E+05 <KM>
SUB_SPACECRAFT_LATITUDE = 4.3945E+01 <DEG>
SUB_SPACECRAFT_LONGITUDE = 2.5550E+02 <DEG>
SPICE_FILE_NAME = {"NAIF0011.TLS",
"DE405.BSP",
"ROS_V24.TF",
"ROS_CHURYUMOV_V01.TF",
"ROS_150414_STEP.TSC",
"CATT_DV_102_01_____00169.BC",
"CORB_DV_102_01_____00169.BSP",
"RORB_DV_102_01_____00169.BSP",
"RATT_DV_102_01_01_____00169.BC"}
DESCRIPTION = "This file contains results from the
Comet Pressure Sensor(COPS)
instrument flown aboard the ROSETTA
spacecraft during its mission to comet
67P/Churyumov-Gerasimenko."
NOTE = "
The values of the keywords SC_SUN_POSITION_VECTOR, SC_TARGET_POSITION_VECTOR,
SC_TARGET_VELOCITY_VECTOR are related to the equatorial J2000 inertial frame.
The values of SUB_SPACECRAFT_LATITUDE and SUB_SPACECRAFT_LONGITUDE refer to
the Cheops reference frame.
The SPACECRAFT_ALTITUDE gives the distance to the spacecraft from the target
center of mass. All values are computed for the time t=START_TIME.
```



Distances are given in <km>, velocities in <km/s>, and angles in <deg>."

```
OBJECT          = COPS_HK_TABLE
  NAME          = COPS_HOUSEKEEPING_TABLE
  INTERCHANGE_FORMAT = ASCII
  ROWS          = 323
  COLUMNS      = 5
  ROW_BYTES     = 80
  ^STRUCTURE    = "COPS_HK.FMT"
END_OBJECT      = COPS_HK_TABLE
```

```
OBJECT          = COPS_SC_DATA_TABLE
  NAME          = COPS_DATA_TABLE
  INTERCHANGE_FORMAT = ASCII
  ROWS          = 150
  COLUMNS      = 3
  ROW_BYTES     = 80
  ^STRUCTURE    = "COPS_DATA.FMT"
END_OBJECT      = COPS_SC_DATA_TABLE
END
```

4.5.3 COPS SR RDR Data Product Design

The particularity of the COPS science structure is the COPS HK table composed by the 5 last standard COPS HK blocks followed by the last extended COPS HK block received by the DPU.

```
PDS_VERSION_ID = PDS3
LABEL_REVISION_NOTE = "2007-09-27,Thierry Semon(UoB),
  version2.1 release;"
RECORD_TYPE      = FIXED_LENGTH
RECORD_BYTES     = 80
FILE_RECORDS     = 583
LABEL_RECORDS    = 95
^COPS_HK_TABLE    = 96
^COPS_SC_DATA_TABLE = 434
DATA_SET_ID      = "RO-C-ROSINA-3-PRL-V1.0"
DATA_SET_NAME    = "ROSETTA-ORBITER 67P ROSINA 3
  PRL V1.0"
PRODUCT_ID       = SR_20140903_225636_3_M0336
PRODUCT_CREATION_TIME = 2015-05-21T12:42:39.959
PRODUCT_TYPE     = RDR
PROCESSING_LEVEL_ID = "3"
MISSION_ID       = ROSETTA
MISSION_NAME     = "INTERNATIONAL ROSETTA MISSION"
TARGET_NAME      = "67P/CHURYUMOV-GERASIMENKO 1 (1969 R1)"
TARGET_TYPE      = "COMET"
MISSION_PHASE_NAME = "PRELANDING"
INSTRUMENT_HOST_NAME = "ROSETTA-ORBITER"
INSTRUMENT_HOST_ID = RO
INSTRUMENT_NAME  = "ROSETTA ORBITER SPECTROMETER FOR
  ION AND NEUTRAL ANALYSIS"
INSTRUMENT_ID    = ROSINA
INSTRUMENT_MODE_ID = M0336
^INSTRUMENT_MODE_DESC = "COPS_MODE_DESC.ASC"
INSTRUMENT_TYPE  = "MASS SPECTROMETER"
DETECTOR_ID      = COPS
DETECTOR_DESC    = "COMET PRESSURE SENSOR"
CHANNEL_ID       = SR
START_TIME       = 2014-09-03T22:57:45.769
```



ROSINA - EAICD

Document No. : RO-ROS-MAN-1039
Issue/Rev. No. : 1.82
Date : 21 March 2016
Page : 61

```
STOP_TIME = 2014-09-03T23:02:45.769
SPACECRAFT_CLOCK_START_COUNT = "1/368405796.39715"
SPACECRAFT_CLOCK_STOP_COUNT = "1/368406096.39715"
PRODUCER_ID = ROSETTA_ROSINA
PRODUCER_FULL_NAME = "KATHRIN ALTWEGG"
PRODUCER_INSTITUTION_NAME = "UNIVERSITY OF BERN"
DATA_QUALITY_ID = "3"
DATA_QUALITY_DESC = "
    0 means 'Detector readout anomaly'
    1 means 'Data related to HK anomaly'
    2 means 'Lossy compression'
    3 means 'Uncompressed or lossless compression'"
SC_SUN_POSITION_VECTOR = (-2.0350E+08 <KM>, 4.0695E+08 <KM>,
    2.3783E+08 <KM>)
SC_TARGET_POSITION_VECTOR = ( 2.7441E+01 <KM>,-4.6683E+01 <KM>,
    2.7593E+01 <KM>)
SC_TARGET_VELOCITY_VECTOR = ( 1.0419E-04 <KM/S>, 2.5691E-04 <KM/S>,
    -1.3900E-04 <KM/S>)
SPACECRAFT_ALTITUDE = 6.0776E+01 <KM>
SUB_SPACECRAFT_LATITUDE = -9.3397E+00 <DEG>
SUB_SPACECRAFT_LONGITUDE = 3.0232E+02 <DEG>
SPICE_FILE_NAME = {"NAIF0011.TLS",
    "DE405.BSP",
    "ROS_V24.TF",
    "ROS_CHURYUMOV_V01.TF",
    "ROS_150414_STEP.TSC",
    "CATT_DV_102_01_____00169.BC",
    "CORB_DV_102_01_____00169.BSP",
    "RORB_DV_102_01_____00169.BSP",
    "RATT_DV_102_01_01____00169.BC"}
DESCRIPTION = "This file contains results from the
    Comet Pressure Sensor(COPS)
    instrument flown aboard the ROSETTA
    spacecraft during its mission to comet
    67P/Churyumov-Gerasimenko."
NOTE = "
    The values of the keywords SC_SUN_POSITION_VECTOR, SC_TARGET_POSITION_VECTOR,
    SC_TARGET_VELOCITY_VECTOR are related to the equatorial J2000 inertial frame.
    The values of SUB_SPACECRAFT_LATITUDE and SUB_SPACECRAFT_LONGITUDE refer to
    the Cheops reference frame.
    The SPACECRAFT_ALTITUDE gives the distance to the spacecraft from the target
    center of mass. All values are computed for the time t=START_TIME.
    Distances are given in <km>, velocities in <km/s>, and angles in <deg>."
OBJECT = COPS_HK_TABLE
NAME = COPS_HOUSEKEEPING_TABLE
INTERCHANGE_FORMAT = ASCII
ROWS = 338
COLUMNS = 5
ROW_BYTES = 80
^STRUCTURE = "COPS_HK.FMT"
END_OBJECT = COPS_HK_TABLE

OBJECT = COPS_SC_DATA_TABLE
NAME = COPS_DATA_TABLE
INTERCHANGE_FORMAT = ASCII
ROWS = 150
COLUMNS = 3
ROW_BYTES = 80
^STRUCTURE = "COPS_DATA.FMT"
```



ROSINA - EAICD

Document No. : RO-ROS-MAN-1039
Issue/Rev. No. : 1.82
Date : 21 March 2016
Page : 62

END_OBJECT
END

= COPS_SC_DATA_TABLE



4.5.4 DFMS CE RDR Data Product Design

```
PDS_VERSION_ID = PDS3
LABEL_REVISION_NOTE = "2007-09-27,Thierry Sémon(UoB),
                        version2.1 release;"
RECORD_TYPE = FIXED_LENGTH
RECORD_BYTES = 80
FILE_RECORDS = 474
LABEL_RECORDS = 79
^DFMS_HK_TABLE = 80
^CEM_DATA_TABLE = 325
DATA_SET_ID = "RO-X-ROSINA-2-ENG-V1.0"
DATA_SET_NAME = "ROSETTA-ORBITER CHECK ROSINA 2
                ENGINEERING V1.0"

PRODUCT_ID = CE_20050706_144901_3_M0160
PRODUCT_CREATION_TIME = 2006-10-19T14:58:40.953
PRODUCT_TYPE = RDR
PROCESSING_LEVEL_ID = "3"
MISSION_ID = ROSETTA
MISSION_NAME = "INTERNATIONAL ROSETTA MISSION"
TARGET_NAME = "CHECKOUT"
TARGET_TYPE = "N/A"
MISSION_PHASE_NAME = "COMMISSIONING"
INSTRUMENT_HOST_NAME = "ROSETTA-ORBITER"
INSTRUMENT_HOST_ID = RO
INSTRUMENT_NAME = "ROSETTA ORBITER SPECTROMETER FOR
                  ION AND NEUTRAL ANALYSIS"

INSTRUMENT_ID = ROSINA
INSTRUMENT_MODE_ID = M0160
^INSTRUMENT_MODE_DESC = "DFMS_MODE_DESC.TXT"
INSTRUMENT_TYPE = "MASS SPECTROMETER"
DETECTOR_ID = DFMS
DETECTOR_DESC = "DOUBLE FOCUSING MASS SPECTROMETER"
CHANNEL_ID = CE
START_TIME = 2005-07-06T14:48:39.583
STOP_TIME = 2005-07-06T14:49:22.583
SPACECRAFT_CLOCK_START_COUNT = "1/79282098.217"
SPACECRAFT_CLOCK_STOP_COUNT = "1/79282141.217"
PRODUCER_ID = ROSETTA_ROSINA
PRODUCER_FULL_NAME = "KATHRIN ALTWEGG"
PRODUCER_INSTITUTION_NAME = "UNIVERSITY OF BERN"
DATA_QUALITY_ID = "3"
DATA_QUALITY_DESC = "
0 means 'Nominal quality, avg. PPM deviance < 500'
1 means 'Self-calibrated, GCU avg. PPM deviance >= 500, SELF < 500'
2 means 'Adopted mass scale avg. PPM deviance >= 500'
3 means 'Enhanced Noise'
4 means 'Not enough peaks found for accurate calibration/verification'"
SC_SUN_POSITION_VECTOR = (-1.1297E+08 <KM>, 5.2998E+08 <KM>,
                          2.9403E+08 <KM>)
SC_TARGET_POSITION_VECTOR = (-9.9031E+05 <KM>,-2.4574E+06 <KM>,
                              -6.3176E+05 <KM>)
SC_TARGET_VELOCITY_VECTOR = ( 2.8994E-01 <KM/S>, 6.9963E-01 <KM/S>,
                              1.7115E-01 <KM/S>)
SPACECRAFT_ALTITUDE = 2.7237E+06 <KM>
SUB_SPACECRAFT_LATITUDE = 3.9417E+01 <DEG>
SUB_SPACECRAFT_LONGITUDE = 3.5145E+02 <DEG>
```



```
SPICE_FILE_NAME      =      {"NAIF0011.TLS",
                             "DE405.BSP",
                             "ROS_V24.TF",
                             "ROS_CHURYUMOV_V01.TF",
                             "ROS_150414_STEP.TSC",
                             "CATT_DV_102_01_____00169.BC",
                             "CORB_DV_102_01_____00169.BSP",
                             "RORB_DV_102_01_____00169.BSP",
                             "RATT_DV_102_01_01_____00169.BC"}
DESCRIPTION          =      "This file contains results from the
                             Double Focusing Mass Spectrometer
                             (DFMS) instrument flown aboard the
                             ROSETTA spacecraft during its mission
                             to comet 67P/Churyumov-Gerasimenko."
NOTE                 =      "
    The values of the keywords SC_SUN_POSITION_VECTOR, SC_TARGET_POSITION_VECTOR,
    SC_TARGET_VELOCITY_VECTOR are related to the equatorial J2000 inertial frame.
    The values of SUB_SPACECRAFT_LATITUDE and SUB_SPACECRAFT_LONGITUDE refer to
    the Cheops reference frame.
    The SPACECRAFT_ALTITUDE gives the distance to the spacecraft from the target
    center of mass. All values are computed for the time t=START_TIME.
    Distances are given in <km>, velocities in <km/s>, and angles in <deg>."

OBJECT               =      DFMS_HK_TABLE
  NAME                =      DFMS_HOUSEKEEPING_TABLE
  INTERCHANGE_FORMAT =      ASCII
  ROWS                 =      39
  COLUMNS             =      5
  ROW_BYTES            =      80
  ^STRUCTURE          =      "DFMS_L3_HK.FMT"
END_OBJECT           =      DFMS_HK_TABLE

OBJECT               =      DFMS_MASS_CAL_TABLE
  NAME                =      DFMS_MASS_CALIBRATION_TABLE
  INTERCHANGE_FORMAT =      ASCII
  ROWS                 =      36
  COLUMNS             =      8
  ROW_BYTES            =      80
  ^STRUCTURE          =      "DFMS_L3_CALINFO.FMT"
END_OBJECT           =      DFMS_MASS_CAL_TABLE

OBJECT               =      CEM_DATA_TABLE
  NAME                =      DFMS_CEM_DATA_TABLE
  INTERCHANGE_FORMAT =      ASCII
  ROWS                 =      150
  COLUMNS             =      6
  ROW_BYTES            =      80
  ^STRUCTURE          =      "DFMS_CE_DATA.FMT"
END_OBJECT           =      CEM_DATA_TABLE
END
```

4.5.5 DFMS FA RDR Data Product Design

```
PDS_VERSION_ID      =      PDS3
LABEL_REVISION_NOTE =      "2007-09-27,Thierry Sémon(UoB),
                             version2.1 release;"
RECORD_TYPE          =      FIXED_LENGTH
RECORD_BYTES         =      80
```



ROSINA - EAICD

Document No. : RO-ROS-MAN-1039
Issue/Rev. No. : 1.82
Date : 21 March 2016
Page : 65

```
FILE_RECORDS = 474
LABEL_RECORDS = 79
^DFMS_HK_TABLE = 80
^FAR_DATA_TABLE = 325
DATA_SET_ID = "RO-X-ROSINA-3-ENG-V1.0"
DATA_SET_NAME = "ROSETTA-ORBITER CHECK ROSINA 3
ENGINEERING V1.0"
PRODUCT_ID = FA_20050209_1610142_3_M0170
PRODUCT_CREATION_TIME = 2006-10-19T15:05:39.187
PRODUCT_TYPE = EDR
PROCESSING_LEVEL_ID = "3"
MISSION_ID = ROSETTA
MISSION_NAME = "INTERNATIONAL ROSETTA MISSION"
TARGET_NAME = "CHECKOUT"
TARGET_TYPE = "N/A"
MISSION_PHASE_NAME = "COMMISSIONING"
INSTRUMENT_HOST_NAME = "ROSETTA-ORBITER"
INSTRUMENT_HOST_ID = RO
INSTRUMENT_NAME = "ROSETTA ORBITER SPECTROMETER FOR
ION AND NEUTRAL ANALYSIS"
INSTRUMENT_ID = ROSINA
INSTRUMENT_MODE_ID = M0170
^INSTRUMENT_MODE_DESC = "DFMS_MODE_DESC.TXT"
INSTRUMENT_TYPE = "MASS SPECTROMETER"
DETECTOR_ID = DFMS
DETECTOR_DESC = "DOUBLE FOCUSING MASS SPECTROMETER"
CHANNEL_ID = FA
START_TIME = 2005-02-09T16:10:14.367
STOP_TIME = 2005-02-09T16:10:56.367
SPACECRAFT_CLOCK_START_COUNT = "1/66586214.240"
SPACECRAFT_CLOCK_STOP_COUNT = "1/66586256.241"
PRODUCER_ID = ROSETTA_ROSINA
PRODUCER_FULL_NAME = "KATHRIN ALTWEGG"
PRODUCER_INSTITUTION_NAME = "UNIVERSITY OF BERN"
DATA_QUALITY_ID = "3"
DATA_QUALITY_DESC = "
0 means 'Nominal quality, avg. PPM deviance < 500'
1 means 'Self-calibrated, GCU avg. PPM deviance >= 500, SELF < 500'
2 means 'Adopted mass scale avg. PPM deviance >= 500'
3 means 'Enhanced Noise'
4 means 'Not enough peaks found for accurate calibration/verification'"
SC_SUN_POSITION_VECTOR = (-1.1297E+08 <KM>, 5.2998E+08 <KM>,
2.9403E+08 <KM>)
SC_TARGET_POSITION_VECTOR = (-9.9031E+05 <KM>,-2.4574E+06 <KM>,
-6.3176E+05 <KM>)
SC_TARGET_VELOCITY_VECTOR = ( 2.8994E-01 <KM/S>, 6.9963E-01 <KM/S>,
1.7115E-01 <KM/S>)
SPACECRAFT_ALTITUDE = 2.7237E+06 <KM>
SUB_SPACECRAFT_LATITUDE = 3.9417E+01 <DEG>
SUB_SPACECRAFT_LONGITUDE = 3.5145E+02 <DEG>
SPICE_FILE_NAME = {"NAIF0011.TLS",
"DE405.BSP",
"ROS_V24.TF",
"ROS_CHURYUMOV_V01.TF",
"ROS_150414_STEP.TSC",
"CATT_DV_102_01_____00169.BC",
"CORB_DV_102_01_____00169.BSP",
"RORB_DV_102_01_____00169.BSP",
"RATT_DV_102_01_01_____00169.BC"}
DESCRIPTION = "This file contains results from the
```



Double Focusing Mass Spectrometer (DFMS) instrument flown aboard the ROSETTA spacecraft during its mission to comet 67P/Churyumov-Gerasimenko."

NOTE = "
The values of the keywords SC_SUN_POSITION_VECTOR, SC_TARGET_POSITION_VECTOR, SC_TARGET_VELOCITY_VECTOR are related to the equatorial J2000 inertial frame. The values of SUB_SPACECRAFT_LATITUDE and SUB_SPACECRAFT_LONGITUDE refer to the Cheops reference frame.
The SPACECRAFT_ALTITUDE gives the distance to the spacecraft from the target center of mass. All values are computed for the time t=START_TIME.
Distances are given in <km>, velocities in <km/s>, and angles in <deg>."

```
OBJECT = DFMS_HK_TABLE
NAME = DFMS_HOUSEKEEPING_TABLE
INTERCHANGE_FORMAT = ASCII
ROWS = 39
COLUMNS = 5
ROW_BYTES = 80
^STRUCTURE = "DFMS_L3_HK.FMT"
END_OBJECT = DFMS_HK_TABLE

OBJECT = DFMS_MASS_CAL_TABLE
NAME = DFMS_MASS_CALIBRATION_TABLE
INTERCHANGE_FORMAT = ASCII
ROWS = 36
COLUMNS = 8
ROW_BYTES = 80
^STRUCTURE = "DFMS_L3_CALINFO.FMT"
END_OBJECT = DFMS_MASS_CAL_TABLE

OBJECT = FAR_DATA_TABLE
NAME = DFMS_FAR_DATA_TABLE
INTERCHANGE_FORMAT = ASCII
ROWS = 150
COLUMNS = 3
ROW_BYTES = 80
^STRUCTURE = "DFMS_FA_DATA.FMT"
END_OBJECT = FAR_DATA_TABLE
END
```

4.5.6 DFMS MC RDR Data Product Design

```
PDS_VERSION_ID = PDS3
LABEL_REVISION_NOTE = "2015-01-01,Thierry Semon (UoB),
Version1.0 release"
SOFTWARE_NAME = "DFMS_PDS_L2_to_L3"
SOFTWARE_VERSION_ID = "2015-10-31,v1.20"
ROSETTA:ROSINA_PIXEL0_A_MASS = 18
ROSETTA:ROSINA_PIXEL0_B_MASS = 18
SOURCE_FILE_NAME = MC_20140425_003631315_M0202
ROSETTA:ROSINA_CAL_ID4 = X0_GCU_20140720_084732_LMHR
ROSETTA:ROSINA_CAL_ID5 = X0_SLF_20140425_003631_LMHR
ROSETTA:ROSINA_CAL_ID6 = SLF_MPST_20150213_110029
RECORD_TYPE = FIXED_LENGTH
RECORD_BYTES = 80
FILE_RECORDS = 701
LABEL_RECORDS = 114
```



ROSINA - EAICD

Document No. : RO-ROS-MAN-1039
Issue/Rev. No. : 1.82
Date : 21 March 2016
Page : 67

```
^DFMS_HK_TABLE = 115
^DFMS_MASS_CAL_TABLE = 154
^MCP_DATA_L3_TABLE = 190
DATA_SET_ID = "RO-C-ROSINA-3-PRL-V1.0"
DATA_SET_NAME = "ROSETTA-ORBITER 67P ROSINA 3
PRL V1.0"

PRODUCT_ID = MC_20140425_003631_3_M0202
PRODUCT_CREATION_TIME = 2015-12-10T13:10:39
PRODUCT_TYPE = RDR
PROCESSING_LEVEL_ID = 3
MISSION_ID = ROSETTA
MISSION_NAME = "INTERNATIONAL ROSETTA MISSION"
TARGET_NAME = "67P/CHURYUMOV-GERASIMENKO 1 (1969 R1)"
TARGET_TYPE = "COMET"
MISSION_PHASE_NAME = "PRELANDING"
INSTRUMENT_HOST_NAME = "ROSETTA-ORBITER"
INSTRUMENT_HOST_ID = RO
INSTRUMENT_NAME = "ROSETTA ORBITER SPECTROMETER FOR
ION AND NEUTRAL ANALYSIS"

INSTRUMENT_ID = ROSINA
INSTRUMENT_MODE_ID = M0202
^INSTRUMENT_MODE_DESC = "DFMS_MODE_DESC.ASC"
INSTRUMENT_TYPE = "MASS SPECTROMETER"
DETECTOR_ID = DFMS
DETECTOR_DESC = "DOUBLE FOCUSING MASS SPECTROMETER"
CHANNEL_ID = MC
START_TIME = 2014-04-25T00:37:36.681
STOP_TIME = 2014-04-25T00:37:56.681
SPACECRAFT_CLOCK_START_COUNT = "1/357006991.31525"
SPACECRAFT_CLOCK_STOP_COUNT = "1/357007011.31525"
PRODUCER_ID = ROSETTA_ROSINA
PRODUCER_FULL_NAME = "KATHRIN ALTWEGG"
PRODUCER_INSTITUTION_NAME = "UNIVERSITY OF BERN"
DATA_QUALITY_ID = "0"
DATA_QUALITY_DESC = "
0 means 'Nominal quality, avg. PPM deviance < 500'
1 means 'Self-calibrated, GCU avg. PPM deviance >= 500, SELF < 500'
2 means 'Adopted mass scale avg. PPM deviance >= 500'
3 means 'Enhanced Noise'
4 means 'Not enough peaks found for accurate calibration/verification'"

SC_SUN_POSITION_VECTOR = (-1.1297E+08 <KM>, 5.2998E+08 <KM>,
2.9403E+08 <KM>)
SC_TARGET_POSITION_VECTOR = (-9.9031E+05 <KM>,-2.4574E+06 <KM>,
-6.3176E+05 <KM>)
SC_TARGET_VELOCITY_VECTOR = ( 2.8994E-01 <KM/S>, 6.9963E-01 <KM/S>,
1.7115E-01 <KM/S>)

SPACECRAFT_ALTITUDE = 2.7237E+06 <KM>
SUB_SPACECRAFT_LATITUDE = 3.9417E+01 <DEG>
SUB_SPACECRAFT_LONGITUDE = 3.5145E+02 <DEG>
SPICE_FILE_NAME = {"NAIF0011.TLS",
"DE405.BSP",
"ROS_V24.TF",
"ROS_CHURYUMOV_V01.TF",
"ROS_150414_STEP.TSC",
"CATT_DV_102_01_____00169.BC",
"CORB_DV_102_01_____00169.BSP",
"RORB_DV_102_01_____00169.BSP",
"RATT_DV_102_01_01_____00169.BC"}

DESCRIPTION = "This file contains results from the
Double Focusing Mass Spectrometer"
```



(DFMS) instrument flown aboard the ROSETTA spacecraft during its mission to comet 67P/Churyumov-Gerasimenko."

NOTE
The values of the keywords SC_SUN_POSITION_VECTOR, SC_TARGET_POSITION_VECTOR, SC_TARGET_VELOCITY_VECTOR are related to the equatorial J2000 inertial frame.
The values of SUB_SPACECRAFT_LATITUDE and SUB_SPACECRAFT_LONGITUDE refer to the Cheops reference frame.
The SPACECRAFT_ALTITUDE gives the distance to the spacecraft from the target center of mass. All values are computed for the time t=START_TIME.
Distances are given in <km>, velocities in <km/s>, and angles in <deg>."

OBJECT = DFMS_HK_TABLE
NAME = DFMS_HOUSEKEEPING_TABLE
INTERCHANGE_FORMAT = ASCII
ROWS = 39
COLUMNS = 5
ROW_BYTES = 80
^STRUCTURE = "DFMS_L3_HK.FMT"
END_OBJECT = DFMS_HK_TABLE
OBJECT = DFMS_MASS_CAL_TABLE
NAME = DFMS_MASS_CALIBRATION_TABLE
INTERCHANGE_FORMAT = ASCII
ROWS = 36
COLUMNS = 8
ROW_BYTES = 80
^STRUCTURE = "DFMS_L3_CALINFO.FMT"
END_OBJECT = DFMS_MASS_CAL_TABLE
OBJECT = MCP_DATA_L3_TABLE
NAME = MCP_DATA_L3_TABLE
INTERCHANGE_FORMAT = ASCII
ROWS = 512
COLUMNS = 6
ROW_BYTES = 80
^STRUCTURE = "DFMS_L3_DATA.FMT"
END_OBJECT = MCP_DATA_L3_TABLE
END

4.5.7 RTOF OS RDR Data Product Design

The same design applies to RTOF SS data

PDS_VERSION_ID = PDS3
LABEL_REVISION_NOTE = "2007-09-27,Thierry Semon(UoB), version2.1 release;"
SOFTWARE_NAME = "RTOF_PDS_L2_to_L3"
SOFTWARE_VERSION_ID = "2015-06-17,v1.0-TS1"
SOURCE_FILE_NAME = OS_20140424_071727157_M0513
ROSETTA:ROSINA_CAL_ID1 = OS_20140424_000000_3_M0173
ROSETTA:ROSINA_CAL_ID2 = M0513_R_20140101_000000
ROSETTA:ROSINA_CAL_ID3 = ADC_TDC_CORR_TABLE_20120101
RECORD_TYPE = FIXED_LENGTH
RECORD_BYTES = 80
FILE_RECORDS = 32207
LABEL_RECORDS = 113
^RTOF_HK_TABLE = 114



ROSINA - EAICD

Document No. : RO-ROS-MAN-1039
Issue/Rev. No. : 1.82
Date : 21 March 2016
Page : 69

```
^RTOF_MASS_CAL_TABLE      =      152
^RTOF_DATA_L3_TABLE      =      157
DATA_SET_ID              =      "RO-C-ROSINA-3-PRL-V1.0"
DATA_SET_NAME           =      "ROSETTA-ORBITER 67P ROSINA 3
                                PRL V1.0"
PRODUCT_ID              =      OS_20140424_071727_3_M0513
PRODUCT_CREATION_TIME   =      2015-10-26T13:34:31.000
PRODUCT_TYPE            =      RDR
PROCESSING_LEVEL_ID     =      "3"
MISSION_ID              =      ROSETTA
MISSION_NAME            =      "INTERNATIONAL ROSETTA MISSION"
TARGET_NAME             =      "67P/CHURYUMOV-GERASIMENKO 1 (1969 R1)"
TARGET_TYPE             =      "COMET"
MISSION_PHASE_NAME      =      "PRELANDING"
INSTRUMENT_HOST_NAME    =      "ROSETTA-ORBITER"
INSTRUMENT_HOST_ID      =      RO
INSTRUMENT_NAME         =      "ROSETTA ORBITER SPECTROMETER FOR
                                ION AND NEUTRAL ANALYSIS"
INSTRUMENT_ID           =      ROSINA
INSTRUMENT_MODE_ID      =      M0513
^INSTRUMENT_MODE_DESC    =      "RTOF_MODE_DESC.ASC"
INSTRUMENT_TYPE         =      "MASS SPECTROMETER"
DETECTOR_ID             =      RTOF
DETECTOR_DESC           =      "REFLECTRON TIME OF FLIGHT"
CHANNEL_ID              =      OS
START_TIME              =      2014-04-24T07:18:32.420
STOP_TIME               =      2014-04-24T07:21:52.420
SPACECRAFT_CLOCK_START_COUNT =      "1/356944647.15795"
SPACECRAFT_CLOCK_STOP_COUNT =      "1/356944847.15795"
PRODUCER_ID            =      ROSETTA_ROSINA
PRODUCER_FULL_NAME      =      "KATHRIN ALTWEGG"
PRODUCER_INSTITUTION_NAME =      "UNIVERSITY OF BERN"
DATA_QUALITY_ID        =      "4"
DATA_QUALITY_DESC       =      "
    0 means 'Nominal quality, avg. PPM deviance < 500'
    1 means 'Self-calibrated, GCU avg. PPM deviance >= 500, SELF < 500'
    2 means 'Adopted mass scale avg. PPM deviance >= 500'
    3 means 'Enhanced Noise'
    4 means 'Not enough peaks found for accurate calibration/verification'
    5 means 'Self-calibrated from only two peaks, uncertain PPM deviance'"
SC_SUN_POSITION_VECTOR  =      (-1.1245E+08 <KM>, 5.3050E+08 <KM>,
                                2.9426E+08 <KM>)
SC_TARGET_POSITION_VECTOR =      (-1.0083E+06 <KM>,-2.5010E+06 <KM>,
                                -6.4243E+05 <KM>)
SC_TARGET_VELOCITY_VECTOR =      ( 2.8987E-01 <KM/S>, 6.9975E-01 <KM/S>,
                                1.7124E-01 <KM/S>)
SPACECRAFT_ALTITUDE     =      2.7721E+06 <KM>
SUB_SPACECRAFT_LATITUDE =      3.9405E+01 <DEG>
SUB_SPACECRAFT_LONGITUDE =      1.3405E+02 <DEG>
SPICE_FILE_NAME         =      {"NAIF0011.TLS",
                                "DE405.BSP",
                                "ROS_V24.TF",
                                "ROS_CHURYUMOV_V01.TF",
                                "ROS_150414_STEP.TSC",
                                "CATT_DV_102_01_____00169.BC",
                                "CORB_DV_102_01_____00169.BSP",
                                "RORB_DV_102_01_____00169.BSP",
                                "RATT_DV_102_01_01_____00169.BC"}
DESCRIPTION             =      "This file contains results from the
                                Reflectron Time Of Flight Spectrometer"
```



(RTOF) instrument flown aboard the ROSETTA spacecraft during its mission to comet 67P/Churyumov-Gerasimenko."

NOTE
The values of the keywords SC_SUN_POSITION_VECTOR, SC_TARGET_POSITION_VECTOR, SC_TARGET_VELOCITY_VECTOR are related to the equatorial J2000 inertial frame.
The values of SUB_SPACECRAFT_LATITUDE and SUB_SPACECRAFT_LONGITUDE refer to the Cheops reference frame.
The SPACECRAFT_ALTITUDE gives the distance to the spacecraft from the target center of mass. All values are computed for the time t=START_TIME.
Distances are given in <km>, velocities in <km/s>, and angles in <deg>."

OBJECT = RTOF_HK_TABLE
NAME = RTOF_HOUSEKEEPING_TABLE
INTERCHANGE_FORMAT = ASCII
ROWS = 38
COLUMNS = 5
ROW_BYTES = 80
^STRUCTURE = "RTOF_HK.FMT"
END_OBJECT = RTOF_HK_TABLE

OBJECT = RTOF_MASS_CAL_TABLE
NAME = RTOF_MASS_CAL_TABLE
INTERCHANGE_FORMAT = ASCII
ROWS = 5
COLUMNS = 7
ROW_BYTES = 80
^STRUCTURE = "RTOF_MASS_CAL.FMT"
END_OBJECT = RTOF_MASS_CAL_TABLE

OBJECT = RTOF_DATA_L3_TABLE
NAME = RTOF_DATA_L3_TABLE
INTERCHANGE_FORMAT = ASCII
ROWS = 32051
COLUMNS = 5
ROW_BYTES = 80
^STRUCTURE = "RTOF_DATA_L3.FMT"
END_OBJECT = RTOF_DATA_L3_TABLE
END

4.6 A label in a close view – CODMAC L3

4.6.1 File Characteristics Data Elements

RECORD_TYPE = FIXED_LENGTH
FILE_NAME = OS_20050323_1930037_3_M9999.TAB

The fixed length record type is used for the ROSINA data.

4.6.2 Data Object Pointers Identification Data Elements

^RTOF_HK_TABLE = 114
^RTOF_MASS_CAL_TABLE = 152



^RTOF_DATA_L3_TABLE = 157

Since attached label are used, the pointers refer to a position in the same file.

4.6.3 Identification Data Elements

DATA_SET_ID = "RO-C-ROSINA-3-PRL-V1.0"
DATA_SET_NAME = "ROSETTA-ORBITER 67P ROSINA 3 PRL V1.0"
PRODUCT_ID = OS_20140424_071727_3_M0513
...
0 means 'Nominal quality, avg. PPM deviance < 500'
1 means 'Self-calibrated, GCU avg. PPM deviance >= 500, SELF < 500'
...
5 means 'Self-calibrated from only two peaks, uncertain PPM deviance''

4.6.4 Descriptive Data Elements

SC_SUN_POSITION_VECTOR = (-1.1245E+08 <KM>, 5.3050E+08 <KM>, 2.9426E+08 <KM>)
SC_TARGET_POSITION_VECTOR = (-1.0083E+06 <KM>,-2.5010E+06 <KM>,-6.4243E+05 <KM>)
SC_TARGET_VELOCITY_VECTOR = (2.8987E-01 <KM/S>, 6.9975E-01 <KM/S>, 1.7124E-01 <KM/S>)
SPACECRAFT_ALTITUDE = 2.7721E+06 <KM>
SUB_SPACECRAFT_LATITUDE = 3.9405E+01 <DEG>
SUB_SPACECRAFT_LONGITUDE = 1.3405E+02 <DEG>



```
SPICE_FILE_NAME      =      {"NAIF0011.TLS",
                              "DE405.BSP",
                              "ROS_V24.TF",
                              "ROS_CHURYUMOV_V01.TF",
                              "ROS_150414_STEP.TSC",
                              "CATT_DV_102_01_____00169.BC",
                              "CORB_DV_102_01_____00169.BSP",
                              "RORB_DV_102_01_____00169.BSP",
                              "RATT_DV_102_01_01_____00169.BC"}
DESCRIPTION          =      "This file contains results from the
                              Reflectron Time Of Flight Spectrometer
                              (RTOF) instrument flown aboard the
                              ROSETTA spacecraft during its mission
                              to comet 67P/Churyumov-Gerasimenko."
NOTE                 =      "
The values of the keywords SC_SUN_POSITION_VECTOR, SC_TARGET_POSITION_VECTOR,
SC_TARGET_VELOCITY_VECTOR are related to the equatorial J2000 inertial frame.
The values of SUB_SPACECRAFT_LATITUDE and SUB_SPACECRAFT_LONGITUDE refer to
the Cheops reference frame.
The SPACECRAFT_ALTITUDE gives the distance to the spacecraft from the target
center of mass. All values are computed for the time t=START_TIME.
Distances are given in <km>, velocities in <km/s>, and angles in <deg>."
```

4.6.5 Data Object Definitions

4.6.5.1 Table objects for COPS

```
OBJECT              =      COPS_HK_TABLE
NAME                =      COPS_HOUSEKEEPING_TABLE
INTERCHANGE_FORMAT =      ASCII
ROWS                =      338
COLUMNS            =      5
ROW_BYTES           =      80
^STRUCTURE          =      "COPS_HK.FMT"
END_OBJECT          =      COPS_HK_TABLE

OBJECT              =      COPS_SC_DATA_TABLE
NAME                =      COPS_DATA_TABLE
INTERCHANGE_FORMAT =      ASCII
ROWS                =      150
COLUMNS            =      3
ROW_BYTES           =      80
^STRUCTURE          =      "COPS_DATA.FMT"
END_OBJECT          =      COPS_SC_DATA_TABLE
```



---Contents of the file COPS_HK.FMT:-----

OBJECT	=	COLUMN
NAME	=	RTOF_HOUSEKEEPING_NAME
DESCRIPTION	=	"Name of the provided housekeeping value. Example: ROSINA_RTOF_SCI_COUNT"
UNIT	=	"S"
DATA_TYPE	=	CHARACTER
START_BYTE	=	2
BYTES	=	32
END_OBJECT	=	COLUMN
OBJECT	=	COLUMN
NAME	=	RTOF_HOUSEKEEPING_STATUS
DESCRIPTION	=	"Status, interpreted value, or discrete value of the housekeeping. Examples: ON; OFF; GAS; HIGH; 10kHz. Field is empty in case of non status housekeeping."
DATA_TYPE	=	CHARACTER
START_BYTE	=	37
BYTES	=	5
END_OBJECT	=	COLUMN
OBJECT	=	COLUMN
NAME	=	RTOF_HOUSEKEEPING_VALUE
DESCRIPTION	=	"Exact value of the housekeeping. Examples: 67; 634; +2.0430E-004; 0X62. Field is empty in case of status housekeeping."
DATA_TYPE	=	CHARACTER
START_BYTE	=	45
BYTES	=	15
END_OBJECT	=	COLUMN
OBJECT	=	COLUMN
NAME	=	RTOF_HOUSEKEEPING_UNIT
DESCRIPTION	=	"Unit of the exact housekeeping value. Examples: V; mA; DegC; ns. Field is empty in case of status housekeeping or unitless values."
DATA_TYPE	=	CHARACTER
START_BYTE	=	63
BYTES	=	5
END_OBJECT	=	COLUMN
OBJECT	=	COLUMN
NAME	=	"SPARE"
DESCRIPTION	=	"Blank padding to fixed record length"
DATA_TYPE	=	"CHARACTER"
START_BYTE	=	69
BYTES	=	10
END_OBJECT	=	COLUMN

--- EOF -----

--- Contents of the file COPS_DATA.FMT: -----

OBJECT	=	COLUMN
NAME	=	TIMESTAMP
DESCRIPTION	=	"DPU UTC Timestamp of the readout"
UNIT	=	"S"
DATA_TYPE	=	ASCII_INTEGER
START_BYTE	=	1
BYTES	=	10
END_OBJECT	=	COLUMN
OBJECT	=	COLUMN



```
NAME = PRESSURE
DESCRIPTION = "Pressure from either NG or RG
              measured in millibar."
UNIT = "MILLIBAR"
DATA_TYPE = ASCII_REAL
START_BYTE = 12
BYTES = 15
END_OBJECT = COLUMN
OBJECT = COLUMN
NAME = "SPARE"
DESCRIPTION = "Blank padding to fixed record length"
DATA_TYPE = "CHARACTER"
START_BYTE = 28
BYTES = 51
END_OBJECT = COLUMN
--- EOF -----
```

The DPU Timestamp values contained in the COPS_DATA.FMT label file are calculated values. The first value correspond exactly to the START_TIME keyword value of the COPS SC EDR Data Product Design, the next Timestamps are just spaced by 2 seconds.

4.6.5.2 Table objects for DFMS

```
OBJECT = DFMS_HK_TABLE
NAME = DFMS_HOUSEKEEPING_TABLE
INTERCHANGE_FORMAT = ASCII
ROWS = 39
COLUMNS = 5
ROW_BYTES = 80
^STRUCTURE = "DFMS_L3_HK.FMT"
END_OBJECT = DFMS_HK_TABLE

OBJECT = DFMS_MASS_CAL_TABLE
NAME = DFMS_MASS_CALIBRATION_TABLE
INTERCHANGE_FORMAT = ASCII
ROWS = 36
COLUMNS = 8
ROW_BYTES = 80
^STRUCTURE = "DFMS_L3_CALINFO.FMT"
END_OBJECT = DFMS_MASS_CAL_TABLE

OBJECT = MCP_DATA_L3_TABLE
NAME = MCP_DATA_L3_TABLE
INTERCHANGE_FORMAT = ASCII
ROWS = 512
COLUMNS = 6
ROW_BYTES = 80
^STRUCTURE = "DFMS_L3_DATA.FMT"
END_OBJECT = MCP_DATA_L3_TABLE
END

OBJECT = CEM_L3_DATA_TABLE
NAME = DFMS_CEM_L3_DATA_TABLE
INTERCHANGE_FORMAT = ASCII
ROWS = 150
COLUMNS = 6
ROW_BYTES = 80
^STRUCTURE = "DFMS_CE_L3_DATA.FMT"
END_OBJECT = CEM_L3_DATA_TABLE
```



ROSINA - EAICD

Document No. : RO-ROS-MAN-1039
Issue/Rev. No. : 1.82
Date : 21 March 2016
Page : 75

```
OBJECT          = FAR_L3_DATA_TABLE
  NAME          = DFMS_FAR_L3_DATA_TABLE
  INTERCHANGE_FORMAT = ASCII
  ROWS          = 150
  COLUMNS      = 3
  ROW_BYTES     = 80
  ^STRUCTURE    = "DFMS_FA_L3_DATA.FMT"
END_OBJECT     = FAR_L3_DATA_TABLE
END
```

--- Contents of the file DFMS_L3_HK.FMT -----

```
OBJECT          = COLUMN
  NAME          = DFMS_HOUSEKEEPING_NAME
  DESCRIPTION    = "Name of the provided housekeeping
                  value. Example: ROSINA_DFMS_CEM_FRONT"
  DATA_TYPE     = CHARACTER
  START_BYTE     = 1
  BYTES         = 34
END_OBJECT     = COLUMN
OBJECT          = COLUMN
  NAME          = DFMS_HOUSEKEEPING_STATUS
  DESCRIPTION    = "Status, interpreted value, or discrete
                  value of the housekeeping. Examples:
                  ON; OFF; LOW; HIGH; 2uA. Field is
                  empty in case of non status
                  housekeeping."
  DATA_TYPE     = CHARACTER
  START_BYTE     = 36
  BYTES         = 7
END_OBJECT     = COLUMN
OBJECT          = COLUMN
  NAME          = DFMS_HOUSEKEEPING_VALUE
  DESCRIPTION    = "Exact value of the housekeeping.
                  Examples: -0.39; 773; 1.4498E+001;
                  OX1E. Field is empty in case of status
                  housekeeping."
  DATA_TYPE     = CHARACTER
  START_BYTE     = 44
  BYTES         = 26
END_OBJECT     = COLUMN
OBJECT          = COLUMN
  NAME          = DFMS_HOUSEKEEPING_UNIT
  DESCRIPTION    = "Unit of the exact housekeeping value.
                  Examples: V; mbar; nA; uA.
                  Field is empty in case of status
                  housekeeping or unitless values."
  DATA_TYPE     = CHARACTER
  START_BYTE     = 71
  BYTES         = 5
END_OBJECT     = COLUMN
OBJECT          = COLUMN
  NAME          = "SPARE"
  DESCRIPTION    = "Blank padding to fixed record length"
  DATA_TYPE     = "CHARACTER"
  START_BYTE     = 77
  BYTES         = 1
```



ROSINA - EAICD

Document No. : RO-ROS-MAN-1039
Issue/Rev. No. : 1.82
Date : 21 March 2016
Page : 76

END_OBJECT = COLUMN
--- EOF -----

--- Contents of file DFMS_L3_CALINFO.FMT-----

OBJECT	=	COLUMN
NAME	=	DFMS_CALINFO_SPECIES
DESCRIPTION	=	"Name of the species available for calibration. Example: ^128Xe^++"
DATA_TYPE	=	CHARACTER
START_BYTE	=	1
BYTES	=	15
END_OBJECT	=	COLUMN
OBJECT	=	COLUMN
NAME	=	DFMS_CALINFO_TYPE
DESCRIPTION	=	"The type of calibration used. a value of 0 indicates "
DATA_TYPE	=	CHARACTER
START_BYTE	=	19
BYTES	=	3
END_OBJECT	=	COLUMN
OBJECT	=	COLUMN
NAME	=	DFMS_CALINFO_FOUND
DESCRIPTION	=	"Indicates whether the species was found within the mass scale."
DATA_TYPE	=	CHARACTER
START_BYTE	=	23
BYTES	=	3
END_OBJECT	=	COLUMN
OBJECT	=	COLUMN
NAME	=	DFMS_CALINFO_PEAKCENTER
DESCRIPTION	=	"The pixel value where the species peak center is found."
DATA_TYPE	=	CHARACTER
START_BYTE	=	27
BYTES	=	11
END_OBJECT	=	COLUMN
OBJECT	=	COLUMN
NAME	=	DFMS_CALINFO_PEAKWIDTH
DESCRIPTION	=	"The width (in pixels) of the species peak."
DATA_TYPE	=	"CHARACTER"
START_BYTE	=	39
BYTES	=	9
END_OBJECT	=	COLUMN
OBJECT	=	COLUMN
NAME	=	DFMS_CALINFO_PEAKHEIGHT
DESCRIPTION	=	"The number of Ions represented by the species peak."
DATA_TYPE	=	"CHARACTER"
START_BYTE	=	49
BYTES	=	12
END_OBJECT	=	COLUMN
OBJECT	=	COLUMN
NAME	=	DFMS_CALINFO_PPMDEV
DESCRIPTION	=	"The parts per million deviation between the found peak mass and the actual mass of the known peak."
DATA_TYPE	=	"CHARACTER"
START_BYTE	=	62



ROSINA - EAICD

Document No. : RO-ROS-MAN-1039
Issue/Rev. No. : 1.82
Date : 21 March 2016
Page : 77

```
      BYTES = 13
END_OBJECT = COLUMN
OBJECT = COLUMN
  NAME = "SPARE"
  DESCRIPTION = "Blank padding to fixed record length"
  DATA_TYPE = "CHARACTER"
  START_BYTE = 76
  BYTES = 3
END_OBJECT = COLUMN
--- EOF -----
```

--- Contents of file DFMS_L3_DATA.FMT-----

```
OBJECT = COLUMN
  NAME = DFMS_L3_DATA_PIXEL
  DESCRIPTION = "The pixel number of the data"
  DATA_TYPE = CHARACTER
  START_BYTE = 1
  BYTES = 3
END_OBJECT = COLUMN
OBJECT = COLUMN
  NAME = DFMS_L3_DATA_MASS_A
  DESCRIPTION = "Row A mass scale value associated with
                 the pixel"
  DATA_TYPE = CHARACTER
  START_BYTE = 5
  BYTES = 17
END_OBJECT = COLUMN
OBJECT = COLUMN
  NAME = DFMS_L3_DATA_IONS_A
  DESCRIPTION = "Row A number of ions associated with
                 the pixel"
  DATA_TYPE = CHARACTER
  START_BYTE = 23
  BYTES = 16
END_OBJECT = COLUMN
OBJECT = COLUMN
  NAME = DFMS_L3_DATA_MASS_B
  DESCRIPTION = "Row B mass scale value associated with
                 the pixel"
  DATA_TYPE = CHARACTER
  START_BYTE = 40
  BYTES = 17
END_OBJECT = COLUMN
OBJECT = COLUMN
  NAME = DFMS_L3_DATA_IONS_B
  DESCRIPTION = "Row B number of ions associated with
                 the pixel"
  DATA_TYPE = CHARACTER
  START_BYTE = 58
  BYTES = 16
END_OBJECT = COLUMN
OBJECT = COLUMN
  NAME = "SPARE"
  DESCRIPTION = "Blank padding to fixed record length"
  DATA_TYPE = "CHARACTER"
  START_BYTE = 75
  BYTES = 4
END_OBJECT = COLUMN
-- EOF -----
```



ROSINA - EAICD

Document No. : RO-ROS-MAN-1039
Issue/Rev. No. : 1.82
Date : 21 March 2016
Page : 78

The first pixel value in counts of LEDA Row A and LEDA Row B is always 0.

--- Contents of file DFMS_CE_L3_DATA.FMT-----

```
OBJECT          = COLUMN
  NAME          = STEP
  DESCRIPTION    = "CEM Step Number. The values are in the
                   range from 1 to 150 and ascending."
  UNIT          = "STEP_NUMBER"
  DATA_TYPE    = ASCII_INTEGER
  START_BYTE    = 1
  BYTES         = 3
END_OBJECT      = COLUMN
OBJECT          = COLUMN
  NAME          = COUNTS
  DESCRIPTION    = "Digital counts of the channeltron."
  UNIT          = "COUNTS"
  DATA_TYPE    = ASCII_INTEGER
  START_BYTE    = 5
  BYTES         = 12
END_OBJECT      = COLUMN
OBJECT          = COLUMN
  NAME          = GAIN
  DESCRIPTION    = "Gain which was used. Default is 16."
  UNIT          = "GAIN_NUMBER"
  DATA_TYPE    = ASCII_INTEGER
  START_BYTE    = 18
  BYTES         = 12
END_OBJECT      = COLUMN
OBJECT          = COLUMN
  NAME          = ANALOG_HG
  DESCRIPTION    = "Analog signal with high-gain."
  UNIT          = "COUNTS"
  DATA_TYPE    = ASCII_REAL
  START_BYTE    = 31
  BYTES         = 15
END_OBJECT      = COLUMN
OBJECT          = COLUMN
  NAME          = ANALOG_LG
  UNIT          = "COUNTS"
  DESCRIPTION    = "Analog signal with low-gain."
  DATA_TYPE    = ASCII_REAL
  START_BYTE    = 47
  BYTES         = 15
END_OBJECT      = COLUMN
OBJECT          = COLUMN
  NAME          = SPARE
  DESCRIPTION    = "Blank padding to fixed record length"
  DATA_TYPE    = CHARACTER
  START_BYTE    = 63
  BYTES         = 16
END_OBJECT      = COLUMN
--- EOF -----
```

--- Contents of file DFMS_FA_L3_DATA.FMT-----

```
OBJECT          = COLUMN
```



ROSINA - EAICD

Document No. : RO-ROS-MAN-1039
Issue/Rev. No. : 1.82
Date : 21 March 2016
Page : 79

```
NAME = STEP
DESCRIPTION = "FAR Step Number. The values are in the
                range from 1 to 150 and ascending."
UNIT = "STEP_NUMBER"
DATA_TYPE = ASCII_INTEGER
START_BYTE = 1
BYTES = 3
END_OBJECT = COLUMN
OBJECT = COLUMN
NAME = VOLTAGE
DESCRIPTION = "Faraday Cup Voltage, Unit: mV"
UNIT = "mV"
DATA_TYPE = ASCII_REAL
START_BYTE = 5
BYTES = 12
END_OBJECT = COLUMN
OBJECT = COLUMN
NAME = "SPARE"
DESCRIPTION = "Blank padding to fixed record length"
DATA_TYPE = "CHARACTER"
START_BYTE = 18
BYTES = 59
END_OBJECT = COLUMN
```

--- EOF -----



4.6.5.3 Table object for RTOF

```
OBJECT = RTOF_HK_TABLE
NAME = RTOF_HOUSEKEEPING_TABLE
INTERCHANGE_FORMAT = ASCII
ROWS = 38
COLUMNS = 5
ROW_BYTES = 80
^STRUCTURE = "RTOF_HK.FMT"
END_OBJECT = RTOF_HK_TABLE
```

```
OBJECT = RTOF_MASS_CAL_TABLE
NAME = RTOF_MASS_CAL_TABLE
INTERCHANGE_FORMAT = ASCII
ROWS = 5
COLUMNS = 7
ROW_BYTES = 80
^STRUCTURE = "RTOF_MASS_CAL.FMT"
END_OBJECT = RTOF_MASS_CAL_TABLE
```

```
OBJECT = RTOF_DATA_L3_TABLE
NAME = RTOF_DATA_L3_TABLE
INTERCHANGE_FORMAT = ASCII
ROWS = 32051
COLUMNS = 5
ROW_BYTES = 80
^STRUCTURE = "RTOF_DATA_L3.FMT"
END_OBJECT = RTOF_DATA_L3_TABLE
END
```

```
--- Contents of file RTOF_HK.FMT-----
OBJECT = COLUMN
NAME = RTOF_HOUSEKEEPING_NAME
DESCRIPTION = "Name of the provided housekeeping
value. Example: ROSINA_RTOF_SCI_COUNT"
DATA_TYPE = CHARACTER
START_BYTE = 2
BYTES = 32
END_OBJECT = COLUMN
OBJECT = COLUMN
NAME = RTOF_HOUSEKEEPING_STATUS
DESCRIPTION = "Status, interpreted value, or discrete
value of the housekeeping. Examples:
ON; OFF; GAS; HIGH; 10kHz. Field is
empty in case of non status
housekeeping."
DATA_TYPE = CHARACTER
START_BYTE = 37
BYTES = 5
END_OBJECT = COLUMN
OBJECT = COLUMN
NAME = RTOF_HOUSEKEEPING_VALUE
DESCRIPTION = "Exact value of the housekeeping.
Examples: 67; 634; +2.0430E-004; OX62.
Field is empty in case of status
housekeeping."
DATA_TYPE = CHARACTER
```



ROSINA - EAICD

Document No. : RO-ROS-MAN-1039
Issue/Rev. No. : 1.82
Date : 21 March 2016
Page : 81

```
START_BYTE = 45
BYTES = 15
END_OBJECT = COLUMN
OBJECT = COLUMN
NAME = RTOF_HOUSEKEEPING_UNIT
DESCRIPTION = "Unit of the exact housekeeping value.
              Examples: V; mA; DegC; ns.
              Field is empty in case of status
              housekeeping or unitless values."

DATA_TYPE = CHARACTER
START_BYTE = 63
BYTES = 5
END_OBJECT = COLUMN
OBJECT = COLUMN
NAME = "SPARE"
DESCRIPTION = "Blank padding to fixed record length"
DATA_TYPE = "CHARACTER"
START_BYTE = 69
BYTES = 10
END_OBJECT = COLUMN
-- EOF -----
--- Contents of file RTOF_MASS_CAL.FMT-----
----
OBJECT = COLUMN
NAME = FRAGMENT_FORMULA
DESCRIPTION = "Formula of the molecule fragment.
              Example: OH. Field is left-justified."

DATA_TYPE = CHARACTER
START_BYTE = 2
BYTES = 15
END_OBJECT = COLUMN
OBJECT = COLUMN
NAME = PEAK_CAL_TYPE
DESCRIPTION = "Numerical identifier of the molecule's
              use in mass calibration. 0 denotes
              peaks used to calibrate GCU spectra
              (therefore typically abundant species
              in the GCU mix). 1 denotes peaks used
              for mass scale verification purposes
              only."

DATA_TYPE = ASCII_INTEGER
START_BYTE = 21
BYTES = 1
END_OBJECT = COLUMN
OBJECT = COLUMN
NAME = PEAK_FOUND
DESCRIPTION = "Numerical identifier of the success or
              failure of the peak-finder to locate
              the peak within the parameters of the
              peak-finding algorithm in the peak's
              assumed bin search window."

DATA_TYPE = ASCII_INTEGER
START_BYTE = 25
BYTES = 1
END_OBJECT = COLUMN
OBJECT = COLUMN
NAME = PEAK_CENTER_BIN
DESCRIPTION = "The peak center returned by the peak-
              finder routine, in bins. Allows for
              10^-3 precision, even though bins are
```



ROSINA - EAICD

Document No. : RO-ROS-MAN-1039
Issue/Rev. No. : 1.82
Date : 21 March 2016
Page : 82

```
integer values, to allow for better
peak-finding and fitting precision."
DATA_TYPE = ASCII_REAL
START_BYTE = 28
BYTES = 11
END_OBJECT = COLUMN
OBJECT = COLUMN
NAME = PEAK_WIDTH
DESCRIPTION = "Width of the fitted Gaussian peak if
if the curvefit was successful, or
zero if the curvefit failed."
DATA_TYPE = ASCII_REAL
START_BYTE = 41
BYTES = 8
END_OBJECT = COLUMN
OBJECT = COLUMN
NAME = PEAK_HEIGHT
DESCRIPTION = "The peak height returned by the peak-
finder routine."
DATA_TYPE = ASCII_REAL
START_BYTE = 51
BYTES = 11
END_OBJECT = COLUMN
OBJECT = COLUMN
NAME = PPM_DEVIANCE
DESCRIPTION = "The difference between the mass of the
molecule in the calibrated mass scale
(via this mass calibration table) from
its known mass, in parts per million
(ppm)."
DATA_TYPE = ASCII_REAL
START_BYTE = 65
BYTES = 11
END_OBJECT = COLUMN
OBJECT = COLUMN
NAME = "SPARE"
DESCRIPTION = "Blank padding to fixed record length"
DATA_TYPE = "CHARACTER"
START_BYTE = 77
BYTES = 2
END_OBJECT = COLUMN
```

--- Contents of file RTOF_DATA_L3.FMT-----

```
OBJECT = COLUMN
NAME = BIN
DESCRIPTION = "Channelnumber. The values are in the
range from 1 to 131099 and ascending."
DATA_TYPE = ASCII_INTEGER
START_BYTE = 1
BYTES = 6
END_OBJECT = COLUMN
OBJECT = COLUMN
NAME = MASS
DESCRIPTION = "The corresponding calibrated mass,
with precision to 10^-8."
DATA_TYPE = ASCII_REAL
START_BYTE = 8
BYTES = 14
END_OBJECT = COLUMN
```



```
OBJECT = COLUMN
  NAME = MASS_UNCERTAINTY
  DESCRIPTION = "The corresponding uncertainty in the
                calibrated mass, with precision to
                10^-8."
  DATA_TYPE = ASCII_REAL
  START_BYTE = 23
  BYTES = 14
END_OBJECT = COLUMN
OBJECT = COLUMN
  NAME = SIGNAL
  DESCRIPTION = "The adjusted signal in counts/second
                with 9 orders of magnitude precision."
  DATA_TYPE = ASCII_REAL
  START_BYTE = 39
  BYTES = 16
END_OBJECT = COLUMN
OBJECT = COLUMN
  NAME = "SPARE"
  DESCRIPTION = "Blank padding to fixed record length"
  DATA_TYPE = "CHARACTER"
  START_BYTE = 56
  BYTES = 23
END_OBJECT = COLUMN
--- EOF -----
```

4.6.6 Parameters Index File Definition

The index files are automatically generated by the PVV program.

4.6.7 Mission Specific Keywords – CODMAC L3

ROSETTA:ROSINA_CAL_ID1:

The ROSETTA missions specific keyword ROSINA_CAL_ID1 identify the calibrated file of data.

ROSETTA:ROSINA_CAL_ID2:

The ROSETTA mission specific keyword ROSINA_CAL_ID2 gives the name of the mass peak table used to locate the peaks in the spectra.

ROSETTA:ROSINA_CAL_ID3:

The ROSETTA mission specific keyword ROSINA_CAL_ID3 gives the name of the file in CALIB containing the RTOF ADC and TDC correction factors used to produce the calibrated data.

ROSETTA:ROSINA_CAL_ID4:

Mass calibration file containing the linear fit for px0 vs mass derived from GCU files. 'None' if no GCU available (after Jan 3. 2015).

ROSETTA:ROSINA_CAL_ID5:

Mass calibration file containing the linear fit for px0 vs mass derived from SLF files.

ROSETTA:ROSINA_CAL_ID6:



ROSINA - EAICD

Document No. : RO-ROS-MAN-1039
Issue/Rev. No. : 1.82
Date : 21 March 2016
Page : 84

Mass calibration file used, only if a calibration peak was found in that file.

ROSETTA:ROSINA_INST_MODEL:

Instrument model FS (Flight model in Space) or FM (Flight model on Ground)

ROSETTA:ROSINA_PIXEL0_A_MASS:

Mass at px0 for mass calibration for row A

ROSETTA:ROSINA_PIXEL0_B_MASS:

Mass at px0 for mass calibration for row B

ROSETTA:DATASET_FOR_FACTOR:

Data set on which calculation is based

ROSETTA:FACTOR_TYPE:

Factors calculation method

ROSETTA:FACTOR_UNCERTAINTY:

Uncertainty of the factors given used in the computation method.